

2025/26

Canon

Delighting You Always

BROADCAST & CINEMA

LENS CATALOG



INNOVATION
In TV Optics Since 1958

Toward 100 years anniversary

CANON'S LENS TECHNOLOGY: WELCOME TO THE 8K & 4K ERA



UHDxs UHD-DIGISUPER 122 AF



UHDxs UHD-DIGISUPER 122



UHDxs UHD-DIGISUPER 111



UHDxs UHD-DIGISUPER 90



UHDxs UHD-DIGISUPER 66



UHDxs CJ27ex7.3B IASE T



UHDxs CJ25ex7.6B



UHDxs CJ15ex4.3B



UHDxs CJ20ex5B



UHDdc CJ14ex4.3B



UHDdc CJ18ex7.6B



UHDxs CJ45ex9.7B



UHDxs CJ45ex13.6B



UHDdc CJ18ex28B



UHDdc CJ24ex7.5B

8K

4K



8K

CN7x17 KAS T
CINE-SERVO 17-120mm T2.95-3.9(RF/PL)



8K

CN8x15 IAS S
CINE-SERVO 15-120mm T2.95-3.95 (EF/PL)



8K

CN10x25 IAS S/E1
CINE-SERVO 25-250mm T2.95-3.95 EF
CINE-SERVO 37.5-375mm T4.4-5.9 PL



8K

CN20x50 IAS H
CINE-SERVO 50-1000mm T5.0-8.9 (EF/PL)



CN-E14-35mm T1.7 L S
CN-E14-35mm T1.7 L SP



CN-E31.5-95mm T1.7 L S
CN-E31.5-95mm T1.7 L SP



CN-E20-50mm T2.4 L F
CN-E20-50mm T2.4 L FP



CN-E45-135mm T2.4 L F
CN-E45-135mm T2.4 L FP



COMPACT-SERVO
18-80mm T4.4 EF



COMPACT-SERVO
70-200mm T4.4 EF



CN-E14mm T3.1 FP X



CN-E20mm T1.5 FP X



CN-E24mm T1.5 FP X



CN-E35mm T1.5 FP X



CN-E50mm T1.3 FP X



CN-E85mm T1.3 FP X



CN-E135mm T2.2 FP X



CN-R14mm T3.1 L F



CN-R20mm T1.5 L F



CN-R24mm T1.5 L F



CN-R35mm T1.5 L F



CN-R50mm T1.3 L F



CN-R85mm T1.3 L F



CN-R135mm T2.2 L F

Broadcast Zoom Lens Lineup



**Studio & Field
Lenses**



**ENG/EFP
Lenses**



**Pro-Video &
Remote-Controlled
Lenses**

4K UHD 2/3"

UHD-DIGISUPER 122AF
4K Premium
UHD_{XS}



UHD-DIGISUPER 122
4K Premium
UHD_{XS}



UHD-DIGISUPER 111
4K Premium
UHD_{XS}



UHD-DIGISUPER 90
4K
UHD_{XS}



UHD-DIGISUPER 66
4K
UHD_{XS}



UHD-DIGISUPER 27
4K Premium
UHD_{XS}



Broadcast ENG/EFP Lenses

4K UHD 2/3"

CJ45ex13.6B
4K **UHD_{XS}**



CJ45ex9.7B
4K **UHD_{XS}**



CJ25ex7.6B
4K **UHD_{XS}**



NEW
 CJ27ex7.3B
4K **UHD_{XS}**



CJ24ex7.5B
4K **UHD_{GC}**



CJ18ex7.6
4K **UHD_{GC}**



CJ14ex4.3B
4K **UHD_{GC}**



CJ18ex28B
4K **UHD_{GC}**



NEW
 CJ20ex5B
4K **UHD_{XS}**



NEW
 CJ15ex4.3B
4K **UHD_{XS}**



HD 2/3"

HJ40ex14B
HD_{XS}



HJ40ex10B
HD_{XS}



KJ22ex7.6B
HD_{GC}



KJ17ex7.7B
HD_{GC}



KJ10ex4.5B
HD_{GC}



Pro-Video Lenses

HD 2/3"

KJ20x8.2B (KRSD)
HD_{GC}



KJ13x6B
HD_{GC}



CANON BROADCAST LENSES

Focal Length Table

Broadcast, Studio and Field Lenses (4K 2/3", HD 2/3")																										
Angle of view horizontal (16:9)	72.9°	66.7°	60.7°	60.1°	58.3°	57.2°	56.1°	54.6°	42.3°	39.1°	3.4°	3.1°	1.02°	0.92°	0.81°	0.80°	0.77°	0.69°	0.68°	0.67°	0.65°	0.59°	0.59°	0.55°	0.47°	
Focal Length (mm)	6.5	7.3	8.2	8.3	8.6	8.8	9	9.3	12.4	13.5	161	180	540	600	675	690	710	800	810	820	840	925	930	1000	1178	
UHD-DIGISUPER 122																										
UHD-DIGISUPER 111																										
UHD-DIGISUPER 90																										
UHD-DIGISUPER 66																										
UHD-DIGISUPER 27																										

Broadcast ENG/EFP Lenses (4K 2/3", HD 2/3")																																						
Angle of view horizontal (16:9)	96.3°	93.7°	77.3°	75.5°	65.2°	64.6°	63.9°	63.2°	58.9°	52.7°	51.3°	38.9°	37.8°	35.5°	19.6°	12.2°	10.5°	9.1°	7.0°	5.2°	4.3°	4.2°	4.0°	3.5°	3.5°	3.4°	3.3°	3.1°	2.89°	1.4°	1.26°	1.1°	1.0°	0.9°				
Focal Length (mm)	4.3	4.5	5	6	6.2	7.5	7.6	7.7	7.8	8.5	9.7	10	13.6	14	15	28	45	52	60	78	100	106	128	131	137	156	158	164	168	180	190	400	437	500	560	612		
CJ27e×7.3B																																						
CJ45e×9.7B																																						
CJ45e×13.6B																																						
CJ25e×7.6B																																						
CJ24e×7.5B																																						
CJ20e×5B																																						
CJ18e×7.6B																																						
CJ18e×28B																																						
CJ15e×4.3B																																						
CJ14e×4.3B																																						
HJ40e×14B																																						
HJ40e×10B																																						
KJ10e×4.5B																																						

Focal Length Table

Pro-Video Lenses (HD 2/3")	
Angle of view horizontal (16:9)	96.3° 93.7° 77.3° 75.5° 65.2° 64.6° 63.9° 63.2° 60.7° 58.9° 51.3° 47.1° 37.8° 35.5° 19.6° 12.2° 10.5° 9.1° 7.0° 5.2° 4.3° 4.2° 4.0° 3.5° 3.5° 3.4° 3.3° 3.1° 1.45° 1.4° 1.1° 1.15° 1.0°
Focal Length (mm)	4.3 4.5 6 6.2 7.5 7.6 7.7 7.8 8.2 8.5 10 11 14 15 28 45 52 60 78 106 128 131 137 156 158 164 168 180 385 400 500 525 560
KJ20x8.2B	[Bar chart showing focal length range from 8.2mm to 560mm]
KJ13x6B	[Bar chart showing focal length range from 6mm to 168mm]

Pro-Video Lenses (HD 1/2")	
Angle of view horizontal (16:9)	75.7° 57.1° 6.8° 3.1°
Focal Length (mm)	4.5 6.4 59 128
KH20x6.4	[Bar chart showing focal length range from 6.4mm to 128mm]
KH13x4.5	[Bar chart showing focal length range from 4.5mm to 59mm]

Understanding Canon Lens Naming Conventions

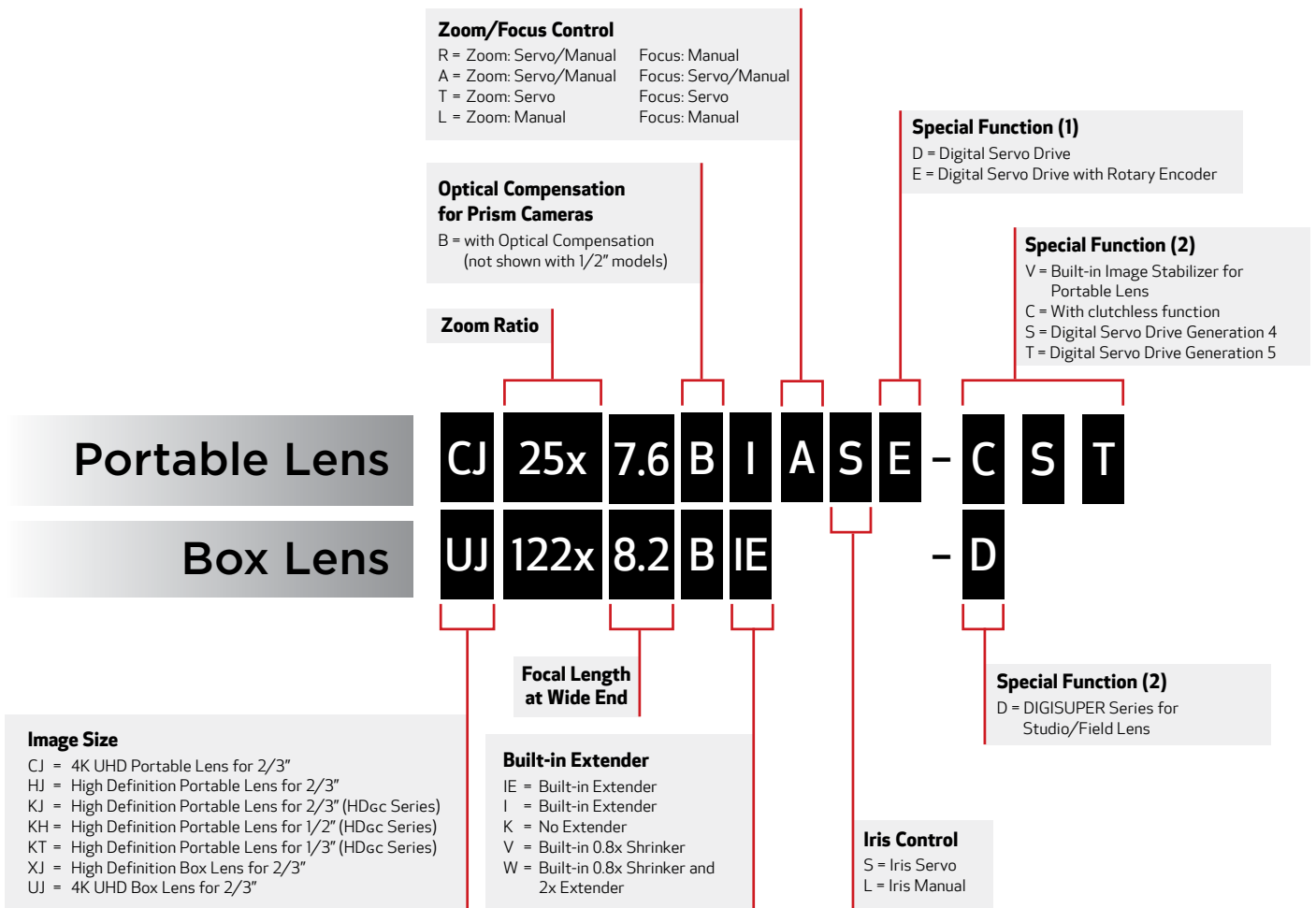

Canon Broadcast Lens Technology

Optical Performance

Superb Optical Materials to Produce a High-Performance Lens

Fluorite · UD Glass · Hi-UD Glass

Unlike conventional optical glass, Fluorite has remarkably low dispersion properties. Realizing the effectiveness of Fluorite glass, Canon has put it to practical use in many lenses, primarily in the anterior section of zoom lenses to help correct telephoto chromatic aberration.



Both UD^{*1} glass and Hi-UD glass^{*2} have dispersion properties similar to Fluorite and are effective for correcting chromatic aberration. Due to its high refractive characteristics, Hi-UD glass is especially known for its spherical aberration correction. Used in the anterior and zooming sections of a lens, Hi-UD glass is effective for controlling aberration fluctuation seen when focusing and zooming.

*1 UD-Ultra Low Dispersion.

*2 Hi-UD High Index Ultra Low Dispersion.

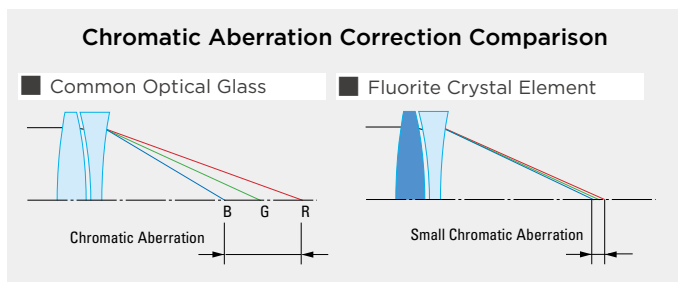

Air Sphere Coating

In the context of HDR Optical imaging, Air Sphere Coating (ASC) technology is a critically important new innovation in broadcast field lenses. This is a Canon-developed technology that is an additional layer deposited on top of the normal multilayer coatings that are used to minimize numerous internal reflections that conspire to lower light transmission efficiency and to contaminate deep black reproduction. ASC is an ultra-low refractive index silicon dioxide film that includes microscopic air spheres having a sub-nanometer diameter arranged in regular structure. Because these spheres are microscopic when

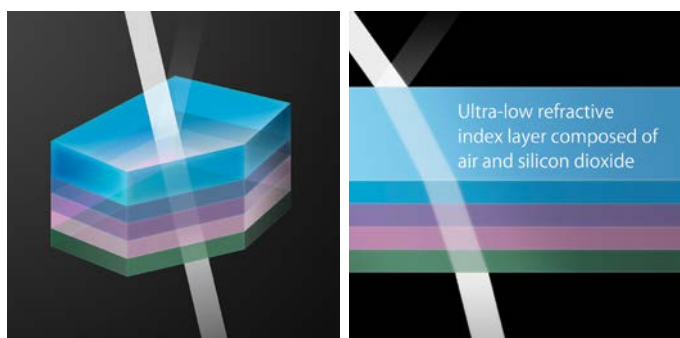

comparing to the wavelength of visible light and as they are in an ordered array, light does not scatter. In combination with the multilayer coatings, ASC achieves far lower reflectance and significantly reduces flare and ghosting.

Bokeh Effect

When shooting in macro, the focus position of the lens can be changed as the focal length is adjusted, when using the optional MCJ-S02 Macro Controller, creating a bokeh effect. This built-in feature can be utilized to support special techniques in which the focus position can be shifted within the same shot just by using the Macro Controller, allowing for subtle creative defocus effects. This can help provide a degree of creativity when shooting live events such as a concert.



Please see page 16 for Bokeh Effect Controller configuration.

High Quality, Compact Size and Weight

Large Aperture Aspheric Lens

Spherical aberration will increase as the diameter of a spherical lens increases. However, aspheric lenses form an ideal shape for aberration correction and are the desired lens type for improving optical performance. As they are more compact, aspheric lenses reduce the weight of the entire lens system. Through its optical design and large aperture processing techniques, Canon has developed compact, large aperture, high magnification field zoom aspheric lenses. As a result of this development, all high-magnification field zoom lenses released since 2000 have a constant total lens length regardless of zoom ratio.

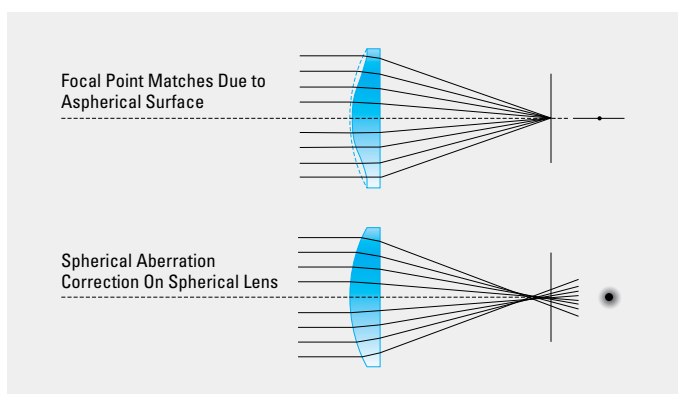

Focus Breathing Suppression

Constant Angle Focusing System (CAFS)

CAFS is a technology that suppresses view-angle fluctuation (breathing) while focusing. The Zooming Effect of Focus is the phenomenon where the picture size (angle of view) changes when focusing. Canon's 32-bit CPU calculates and controls the zoom when focusing in order to counteract this phenomenon. As a result of CAFS, the UHD-DIGISUPER and DIGISUPER Series has zero Zooming Effect of Focus.

Advanced Design Technology to Help Minimize Various Aberrations

Image Stabilizer (IS)

Canon launched its first field zoom lens with a shift type anti-vibration mechanism in 2000*. Prior to that, Canon introduced the IS-20B anti-vibration adapter for portable zoom lenses. Those cutting-edge technologies, along with the Vari-angle Prism image stabilizer (VAP-IS) lens, helped to usher in the era of optical image stabilization in broadcasting lenses.

*Adopted for DIGISUPER 86 XS (XJ86 × 9.3 B). The world's first field zoom lens for broadcasting.

Auto Focus

TTL Secondary Imaging Phase Difference Detection Method

The Secondary Imaging Phase Difference Detection Method, also used in single lens reflex EOS camera lenses, was adopted for broadcast autofocus systems. As a result of this Method, Canon's Auto Focus System has excellent focusing accuracy within the entire zoom range, along with outstanding focusing speed. Due to high performance servo motors, tracking a moving object at high speed can be possible even from a largely out of focus state.

Autofocus Two Types of Operation

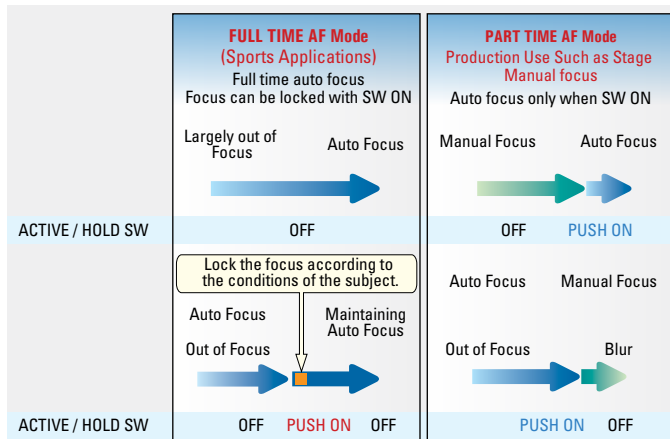

AF Mode

Select DIGISUPER lenses provide two autofocus modes. "FULL TIME AF" provides continuous autofocus operation allowing the camera operator to focus on framing the subject. "PART TIME AF" allows for temporary autofocus use with manual focus. The modes can be switched on and off as needed, using the ACTIVE/HOLD switch.

AF In-Focus Display

By using the FDJ - P41 dedicated focus demand, you can change the size (3 options) and position of the AF in-focus frame displayed on the viewfinder*.

*To change the in-focus frame, it is necessary to interlock with the camera.

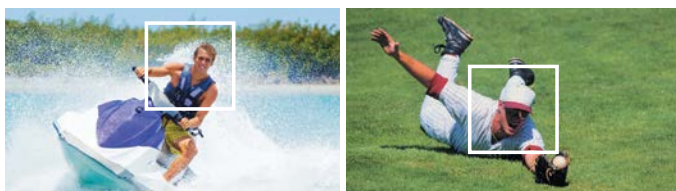

Digital Technology

Digital Servo System/Digital Drive Unit

Since the release of the DIGISUPER 70 in 1995, Canon has been a leader in digital broadcast zoom lens control. Canon's ENG/EFP lenses, having the same digital technology, offer a wealth of features to make shooting more efficient. Canon's digital drive unit is installed in all ENG/EFP and Provideo broadcast lenses.

Shuttle Shot

At the touch of a button, this feature allows the operator to zoom back and forth instantly between any two positions at the maximum speed or at any speed memorized in the Speed Presets.

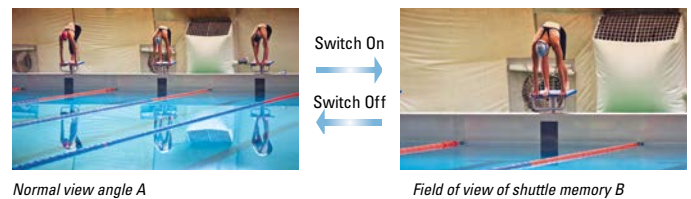

Frame Preset

With the Frame Preset feature, a preset frame position can be saved and repeated multiple times.

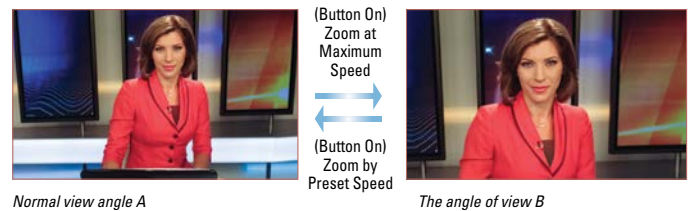

Speed Preset

Simply press a button to recall the preset zoom speed.

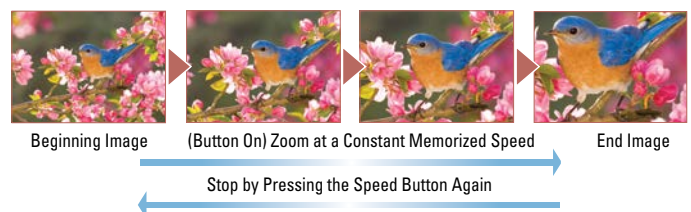

Zoom Servo Characteristics

Zoom Servo Characteristics can be selected from nineteen curvature options on the ZDJ-G01 zoom demand.

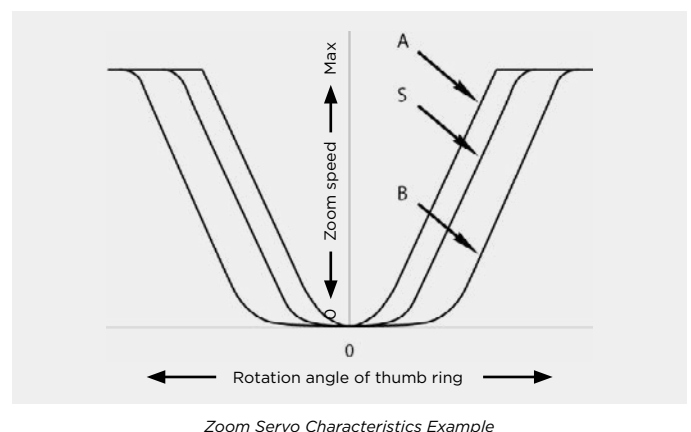

Virtual Studio System

Canon has a series of HDxs and HDGC (IRSE/IASE version) lenses which are equipped with an enhanced digital drive unit. The digital drive unit's 16-bit encoder makes detection and output of positional information possible at a much higher resolution than an analog position sensor (equivalent to 10 bits). The 16-bit resolution rotary encoder built into the drive unit can be integrated into a virtual studio system. The encoders enable precise control as the zoom servo has a range of 0.5 second quick zooms to over a 5 minute super slow zoom. Repeatability in focus and iris control are also precise. Canon's technology has made the encoder device very small, allowing it to be installed in the existing drive unit without adding size or weight.

Further Improving Operational Efficiency

Type T Drive Unit

Canon has improved the operational efficiency of its lenses with the adoption of the Type T Drive Unit ^{*1}.

- The iris is faster compared to conventional Digital Drive Units. Achieves the same focus speed as wide-angle or standard lenses.
- The on-board Focus Breathing Compensation eliminates variation (breathing) in angle of view.
- High-resolution 16-bit absolute value encoder (zoom and focus). It can be used without initialization at the same time as power-on.
- 12-Pin Serial Communication
- 3 Canon standard 20-Pin Connectors are included
- Highly versatile USB Type-C and Information Display Menu

■ Zoom Track

The zoom control range can be set within a more limited range on both the telephoto and wide-angle sides of UHD-DIGISUPER and DIGISUPER Series lenses. With these lenses and the optional ZDJ-P01 zoom demand, the zoom range can be set to virtually any range smaller than the full focal range of the lens. If not used to limit the zoom range, the feature can be used to memorize an additional preset zoom position.

Ergonomic Design

Ergonomic Design Drive Unit

Carrying on previous models' design, the grip design is based on ergonomics, providing an outstanding feel during operation. Use of a free-form surface that adjusts to the shape of the hand along with placement of a rubber finger rests give it better hold, and additional space in the focus ring area makes manual focusing easier. The grip is positioned close to the lens optical axis to eliminate discomfort when holding and reduce fatigue when using the camera shoulder-mounted.

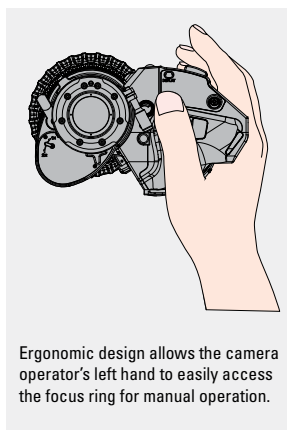

Ergonomic design allows the camera operator's left hand to easily access the focus ring for manual operation.

THE NEW ERA OF

NEW BCTV LENSES DESIGNED TO SUPPORT THE TRANSITION TO 4K UHD CONTENT CREATION

HDTV is now firmly established worldwide and HD production is expected to continue for many years to come. Ultra HDTV - generally referred to as UHD - has more recently emerged as the next generation of enhanced television service. In 2015 the International Telecommunications union published their ITU-R BT.2020 standard "Parameter Values for UHDTV Systems for Production and international Program Exchange" - that included both 4K UHD and 8K UHD production formats. This standard includes a Wide Color Gamut (WCG). In 2016 they published the ITU-R BT.2100 standard "Image Parameter Values for High Dynamic Range Television for use in Production and International Program Exchange". This standard specifically applies the High Dynamic Range (HDR) to the HD, 4K UHD, and 8K UHD production formats (all exclusively progressive scan). In September 2017 the industry body - Ultra HD Forum - published their updated Guidelines on technologies and practices that support a commercially deployable Ultra HD real-time linear service with live and pre-recorded content in 2016, which is termed a "UHD Phase A" service. They include 4K UHD and 1080P HD (that includes both HDR and WCG).

These standards and guidelines have spurred increasing attention to the adoption of 4K UHD origination of sports, concerts, and major events. The anticipated protracted coexistence of HDTV and UHDTV has spawned a new generation of 2/3-inch multi format broadcast camera systems - from most of the major international camera manufacturers - that can selectively originate HD or UHD. To support this new era of mixed HD / UHD origination Canon has invested heavily into the development of an array of 2/3-inch 4K UHD broadcast lenses that encompass long zoom field lenses, a studio lens, and a broadening family of portable lenses.

STUDIO / FIELD BOX LENSES			EFP / ENG PORTABLE LENSES		
LENS SERIES	PERFORMANCE		LENS SERIES	PERFORMANCE	
UHDxs	4K Premium	↑ 1080P/HDR/WCG	UHDxs	4K	↑ 1080P/HDR/WCG
UHDxs	4K		UHDGC	4K	
HDxs	HD		HDxs	HD	
		HDGC	HD		

Simplistic mapping of the performance levels within the separate categories of box lenses and portable lenses.

IMPLICATIONS OF HDR AND WCG

Delivering the requisite high image sharpness required for 4K UHD - while simultaneously lowering traditional optical aberrations (that can be more exposed by the high resolution image sensors) - called for multiple innovations in lens design and manufacturing. Lateral chromatic aberration causes color misregistration on high contrast edges within the imagery - especially toward picture extremities. Longitudinal chromatic aberration causes color fringing on any speculars with this imagery. HDR and WCG further enhance the visibility of these

ENHANCED HDTV AND UHD TV

aberrations - because of the elevation in the color volume of the camera video - placing a greater onus on suppressing them to where they become subjectively invisible.

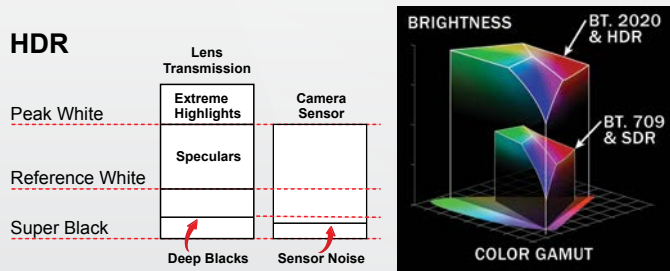

To support HDR the lens must accurately reproduce scene speculars and minimize optical artifacts stimulated by strong scene highlights.

UHD LENS PERFORMANCE HIERARCHY

In the case of the large box field and studio lenses and the portable EFP/ENG lenses Canon has created two performance levels in each. A special priority is assigned to elevating image sharpness (the essence of 4K UHD). An attendant high priority underlies design strategies that aggressively curtail the visibility of the two chromatic aberrations. Higher luminance levels and allied greater color volume associated with HDR / WCG combine to elevate the visibility of even small levels of these chromatic aberrations.

In the case of the Box lenses advanced design strategies allied with advanced optical glass materials are mobilized to maintain high image sharpness across the image plane, over the total focal ranges, and over a wide range of object distances. The 4K PREMIUM box lenses take these strategies to a particularly high level to further tighten those optical performance specifications.

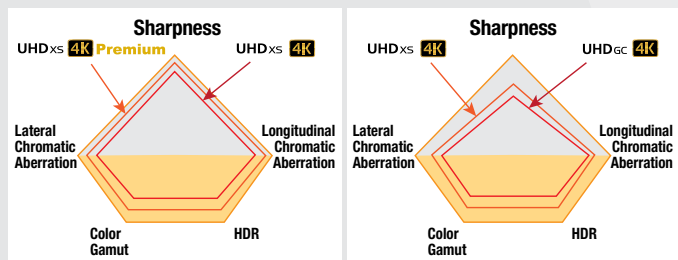

In the case of the portable lenses, similar priorities apply. The UHDxs manifests higher sharpness and lower chromatic aberrations when compared to the UHDgc - although on a different scale to the box lenses.

MULTI-GROUP ZOOMING SYSTEM

In seeking longer focal ranges for the box field and studio lenses and some of the longer focal length portable lenses, challenges in achieving the requisite zooming speeds while also achieving UHD performance were escalated. This called for a radical new design approach to the zooming optical subsystems. The central goals were to achieve greater control over multiple lens aberrations to help ensure full 4K performance while at the same time expediting an increase in the speed of the zooming action (when the digital drive unit is set to maximum zoom speed).

The traditional two group zooming system (right picture) is being replaced with a three group zooming system (left picture). Three movable groups move differentially with respect to each other over the zoom range. Design optimization consisted in balancing the weight of the three individual groups with their stroke distance during zooming action.

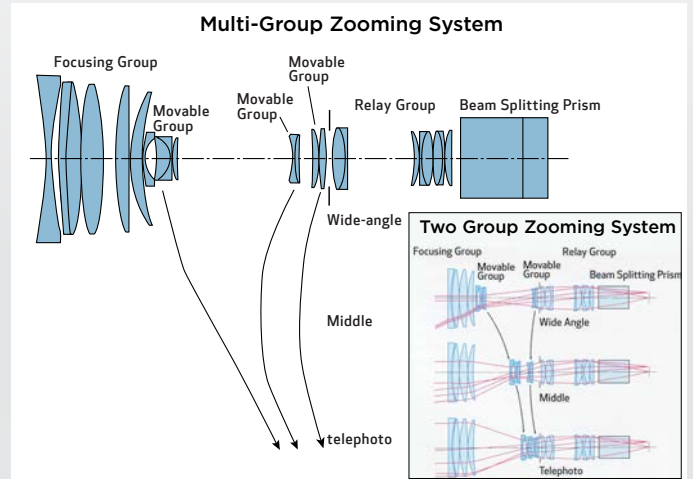

FLOATING FOCUSING SYSTEM

The focus optical subsystem entails high responsibility for numerous optical performance parameters and operational considerations. The lens maximum relative aperture is largely determined by the diameter of this lens input optical grouping. In addition, focus breathing (undesirable alteration to the field angle as the focus control is actuated) characteristics and aberration behavior are associated with this optical subsystem. Overall lens size and weight are heavily proportional to decisions made in the overall design of this system. Central to the design is curtailing the size and weight of the moving lens system. To help ensure UHD optical performance focus fluctuations must be suppressed - and this was accomplished by using two separate moving groups.

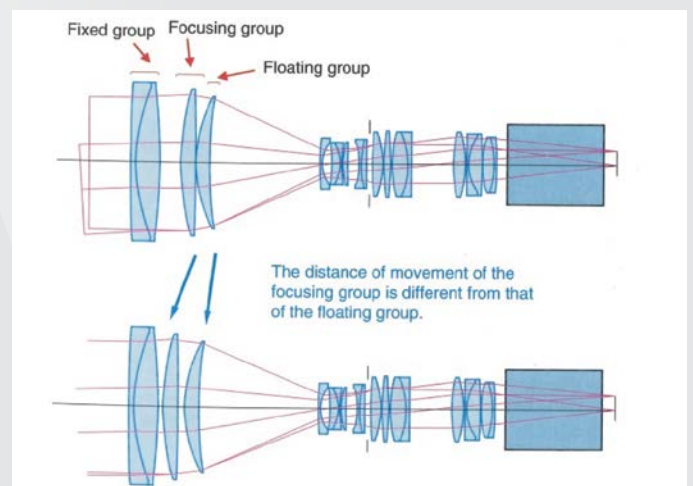

New innovations in a floating focus group support 4K UHD performance while curtailing size and weight

Broadcast Studio/Field Lenses

4K UHD 2/3"

	UHD-DIGISUPER 122AF UHDxS		UHD-DIGISUPER 122 UHDxS		UHD-DIGISUPER 111 UHDxS		UHD-DIGISUPER 27 UHDxS	
Appearance	 4K Premium <small>IMAGE STABILIZER</small>		 4K Premium <small>IMAGE STABILIZER</small>		 4K Premium <small>IMAGE STABILIZER</small>		 4K Premium	
Model Name	UJ122x8.2B AF		UJ122x8.2B		UJ111x8.3B		UJ27x6.5B	
Zoom Ratio	122x		122x		111x		27x	
Focal Length	8.2 – 1000 mm	16.4 – 2000 mm	8.2 – 1000mm	16.4 – 2000mm (2.0x)	8.3 – 925mm	16.6 – 1850 mm (2.0x)	6.5 – 180mm	13 – 360mm (2.0x)
Maximum Relative Aperture	1:1.7 (8.2-340mm) 1:5.0 (1000mm)	1:3.4 (16.4-690mm) 1:10.0 (2000mm)	F1.7 (8.2 – 340mm) F5.0 (1000mm)	F3.4 (16.4 – 680mm) F10.0 (2000mm)	F1.7 (8.3 – 340mm) F4.65 (925mm)	F3.4 (16.6 – 680mm) F9.3 (1850mm)	F1.5 (6.5 – 123mm) F2.2 (180mm)	F3.0 (13 – 246mm) F4.4 (360mm)
Angular Field of View	60.7° x 36.5° (8.2mm) 0.55° x 0.31° (1000mm)	32.6° x 18.7° (16.4mm) 0.28° x 0.15° (2000mm)	60.7° x 36.5° (8.2mm) 0.55° x 0.31° (100mm)	32.6° x 18.7° (16.4mm) 0.28° x 0.15° (2000mm)	60.1° x 36.0° (8.3mm) 0.59° x 0.33° (925mm)	32.3° x 18.5° (16.6mm) 0.30° x 0.17° (1850mm)	72.9° x 45.1° (6.5mm) 3.1° x 1.7° (180mm)	40.5° x 23.5° (13mm) 1.5° x 0.9° (360mm)
M.O.D.*	3.0 m		3.0m		3.0m		0.6m	
Object Dimensions at M.O.D.*	314.6x177.0cm1 (8.2mm) 2.7x1.5cm (1000mm)	157.3x88.5cm1 (16.4mm) 1.4x0.8cm(2000mm)	314.8x177.1cm (8.2mm) 2.7x1.5cm (1000mm)	157.4x88.6cm (16.4mm) 1.4x0.8cm (2000mm)	311.6x175.3cm (8.3mm) 2.9x1.6cm (925mm)	155.8x87.7cm (16.6mm) 1.5x0.8cm (1850mm)	106.1x59.7cm (6.5mm) 3.8x2.1cm (180mm)	53.1x29.9cm (13mm) 1.9x1.1cm (360mm)
Approx. Size (WxHxL)	Approx. 250.6 x 255.5 x 662.0 mm		9.9x10.1x25.1 in. (250.6x255.5x637.4mm)		9.9x10.1x25.1 in. (250.6x255.5x637.4mm)		9.9x10.1x21.7 in. (250.6x255.5x550mm)	
Approx. Weight	61.73 lbs (28.0kg) ※		58.6 lbs (26.6kg) ※		58.6 lbs (26.6kg) ※		47.4 lbs (21.5kg) ※	

4K UHD 2/3"

	UHD-DIGISUPER 90 UHDxS		UHD-DIGISUPER 66 UHDxS	
Appearance				
Model Name	UJ90x9B		UJ66x9B	
Zoom Ratio	90x		66x	
Focal Length	9 – 810mm	18 – 1620mm (2.0x)	9 – 600mm	18 – 1200mm (2.0x)
Maximum Relative Aperture	F2.4 (9 – 486mm) F4.0 (810mm)	F4.8 (18 – 972mm) F8.0 (1620mm)	F1.7 (9 – 340mm) F3.0 (600mm)	F3.4 (18 – 680mm) F6.0 (1200mm)
Angular Field of View	56.1° x 33.4° (9mm) 0.68° x 0.38° (810mm)	29.9° x 17.1° (18mm) 0.34° x 0.19° (1620mm)	56.1° x 33.4° (9mm) 0.92° x 0.52° (600mm)	29.9° x 17.1° (18mm) 0.46° x 0.26° (1200mm)
M.O.D.*	3.0m		3.0m	
Object Dimensions at M.O.D.*	287.9x161.9cm (9mm) 3.3x1.9cm (810mm)	144.0x81.0cm (18mm) 1.7x1.0cm (1620mm)	287.9x161.9 cm (9mm) 4.4x2.5 cm (600mm)	144.0x81.0 cm (18mm) 2.2x1.3 cm (1200mm)
Approx. Size (WxHxL)	9.9x10x24 in. (250.6x255.5x610mm)		9.9x10.1x24.0 in. (250.6x255.5x610mm)	
Approx. Weight	51.2 lbs (23.2kg) ※		51.1 lbs (23.2kg) ※	

UHD-DIGISUPER 122: Highlights

High Zoom Ratio and Long Focal Length

Fulfilling the demands of professional broadcast demands, the UHD-DIGISUPER 122 lens combines a high zoom ratio with performance that surpasses 4K requirements.

Elimination of Image “Lag” Following Operational Pan/Tilt Movements

The image stabilization system must be capable of distinguishing between unwanted shake to the lens-camera system and deliberate operator movement of the camera.

In the UHD-DIGISUPER 122 lens, new correction methods have been implemented. As a result, the vibration component of the sensor detection signal and the panning operation component can be separated rapidly and with high accuracy.

Ideally Suited to 4K Shooting

The UHD-DIGISUPER 122 is ideal for high end live sports and broadcast programming due to its exceptional optical performance that ensures it meets all 4K broadcasting requirements.

Air Sphere Coating (ASC) Technology

This is a Canon-developed technology that is an additional coating deposited on top of the normal multilayer coatings. By doing so, unwanted internal reflections which contaminate deep blacks and lower light transmission are minimized to deliver better image quality.



Bokeh Effect Controller

When shooting in macro, the focus position of the UHD-DIGISUPER 122 can be changed as the focal length is adjusted, when using the optional MCJ-S02 Macro Controller. This built-in feature can be utilized to support special techniques in which the focus position can be shifted within the same shot just by using the Macro Controller, allowing for subtle creative defocus effects. This can help provide a degree of creativity when shooting live events such as a concert.

Compatibility with HD Lens Systems

The lens enables the use of the same Canon standard controllers for zoom and focus as well as servo modules currently used by HD equipment. It comes with a 20-pin connector compatible with virtual units and that enables high-accuracy position information of the zoom, focus and iris to be read out.

Zoom Demand

ZDJ-G01

ZDJ-S01



¹ The unit pictured is the ZDJ-G01

² Not available on the ZDJ-S01

³ This is a framing preset switch on the ZDJ-S01

Main Features

Frame Preset/Shuttle Shot/Speed Preset

ZDJ-G01

ZDJ-S01⁴

This function moves to a preset zoom position with the push of a switch. Frame preset and shuttle shot each moves at maximum speed, while speed preset moves at a preset speed. Letting go of the switch in shuttle shot returns to the original position. Moving speed with framing preset can be set with the ZDJ-G01.

⁴ Supports framing preset only

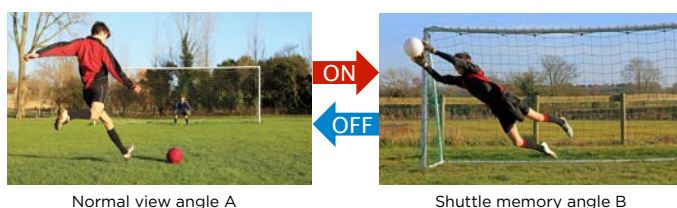

Zoom Track

ZDJ-G01

ZDJ-S01

Zoom control range can be set for both the wide angle and telephoto sides, to control zoom range required for actual shooting.

Other Functions

ZDJ-G01

User settings can be registered and functions can be assigned to switches from the display screen. Preset speeds can also be set, and curves can be selected. Users can also check connection status and see whether various functions are on or off.

Control Accessories for Studio/Field Lenses

Zoom Curve

With zoom demand, the zoom curve (zoom speed curve characteristics according to thumb ring rotation angle) can be selected from provided patterns. The ZDJ-S01 features three types of zoom curves in total, while the ZDJ-G01 offers a total of 19 types; from these, three types of curves can be assigned to the selector switch so users can set the optimum zoom curve for the shooting setting, such as studio recording or live sports.

Available Zoom Curves

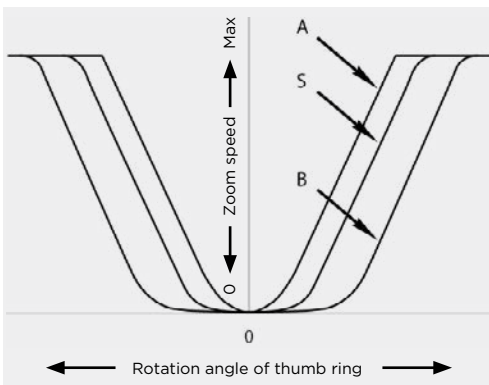

Output Curve 00*

This is the standard zoom curve available in the ZDJ-G01/S01. Curve A offers a faster zoom speed with smaller thumb ring rotation angle, making it ideal for high-speed zoom operation. Curve B is the opposite of Curve A, making it useful for operation at lower zoom speeds. Curve S is midway between A and B.

* Default setting on the ZDJ-G01

ZDJ-G01

ZDJ-S01

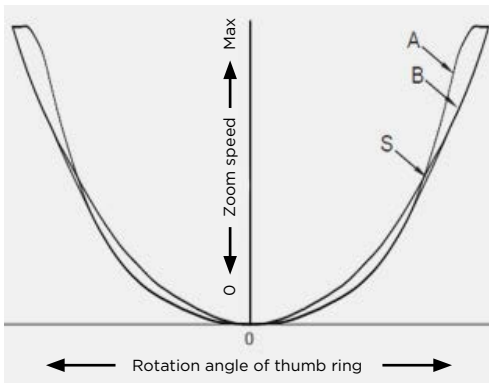

Output Curve 09

This is an example of the selectable zoom curves available with the ZDJ-G01. This zoom curve is ideal for fine zoom operation at medium speed. Curve A gives more priority to fine zoom operation, while Curve B places greater emphasis on trackability. Curve S is similar to A in low speed ranges, and similar to Curve B in high speed ranges.

ZDJ-G01

ZDJ-S01

Curve Selection and Settings



Display Makes Curve Settings Simple and Clear

In line with Canon's aim to maximize operator comfort and convenience, a built in LCD screen on the ZDJ-G01 allows for easy selection of zoom curves as well as rocker direction. This allows operators to change curve settings to suit any changes in the operating environment on the fly.

ZDJ-G01

ZDJ-S01



Switch Curves Directly with Switch on Side of Unit

Switch from among three zoom curves including the assigned output curves according to the situation.

ZDJ-G01

ZDJ-S01

Focus Demand

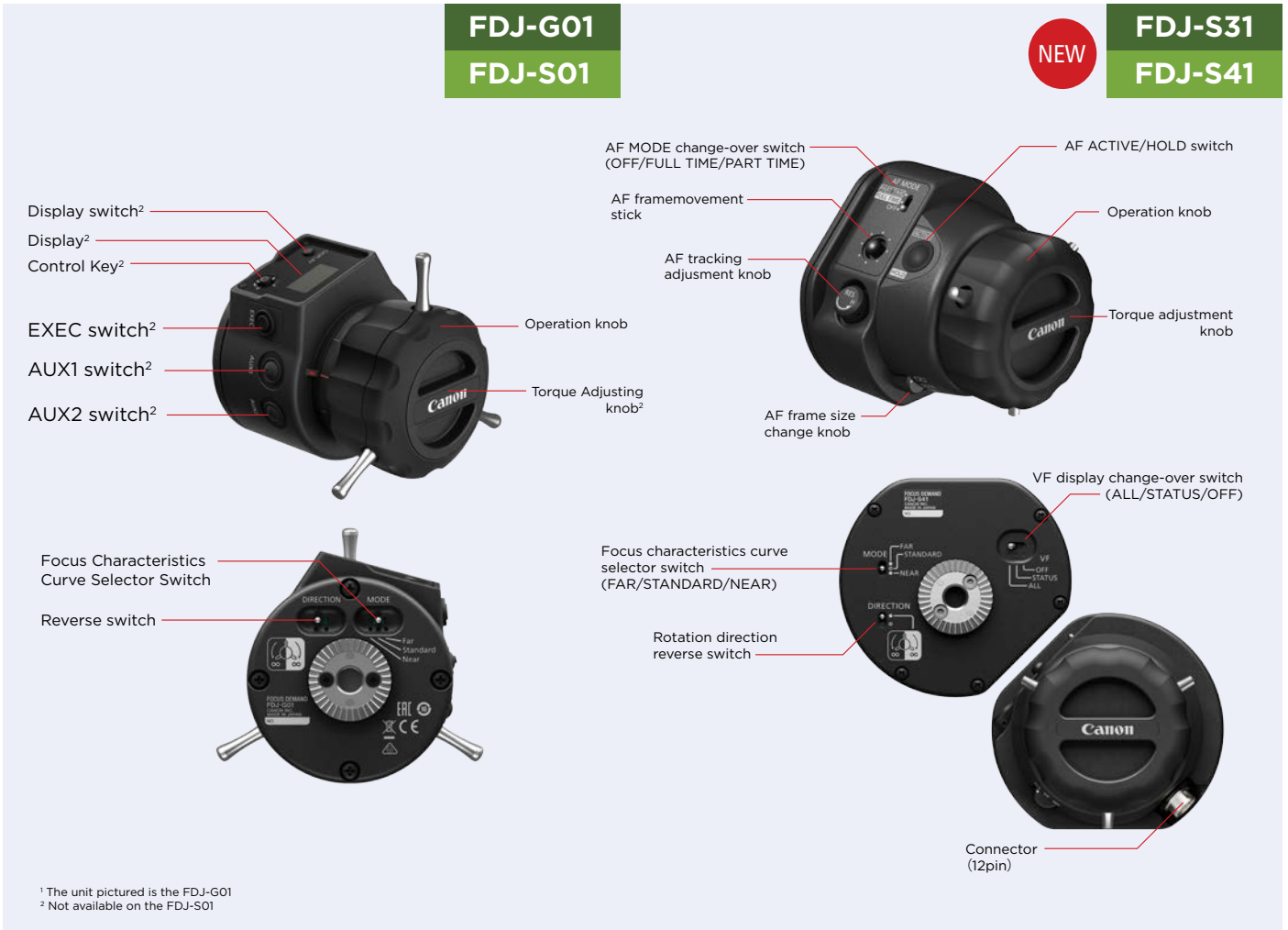

Main Features

FDJ-G01

Focus Range Limit

Focusing within the required range is made possible by limiting the focus range to the subject's range of movement. This is effective for situations such as sports and stage events where subjects are restricted to a certain space and focus range is fixed to some extent.



Focus Preset

This feature lets users move from the current position to a predetermined focus position with the push of a switch. When released, focus returns to the position shown on the operation knob.



Fine Focus Mode 1/2

This function adjusts precision of focusing. Setting 1 sets a range and enables fine focusing within that range. Setting 2 enables fine focusing from the current focus position.



Other Features

User settings can be registered and functions can be assigned to switches from the display screen. Preset speeds can also be set, and curves can be selected. Users can also check connection status and see whether various functions are on or off.

Control Accessories for Studio/Field Lenses

Focus Curve

With the focus demand, the focus curve (focus position in relation to knob position) can be selected from provided patterns. The FDJ-S01 features three types of focus curves in total, while the FDJ-G01 offers a total of 19 types; users can switch between 9 types in Far mode and Near mode to choose the optimum focus curve for the shooting situation.

Available Focus Curves

Focusing within the required range is made possible by limiting the focus range (subject distance). This is effective for situations such as stage performances, where focus range is fixed to some extent.

FDJ-G01

FDJ-S01

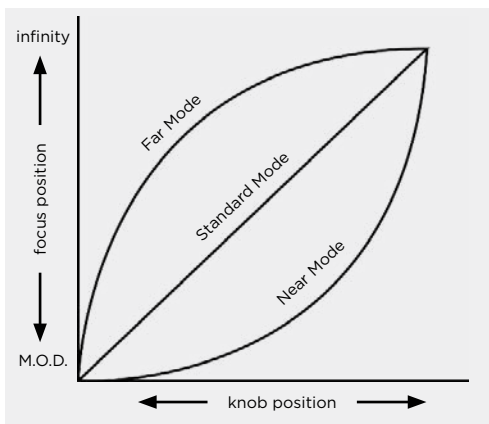

Far Mode

This is the curve in which the focus position changes less the more the knob is turned toward the infinity side. This makes fine adjustments easy on the infinity side.

Standard Mode

This is the standard mode where focus position change is in direct relation to knob operation.

Near Mode

This is the opposite of Far mode, in which focus position changes less the more the knob is turned toward the close side. This makes fine adjustments easy on the close side.

AF Function-switch

FDJ-S31

FDJ-S41



AF MODE Change-Over Switch

The AF MODE switch offers three modes including OFF. Users can select from OFF, FULL TIME, and PART TIME.

- **OFF:** When AF function is not used (AF does not move).
- **FULL TIME:** Always in AF mode.
- **PART TIME:** Starts AF mode when ACTIVE/HOLD switch is pressed.

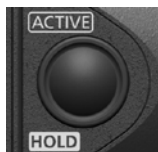

AF ACTIVE/HOLD switch

The function changes as follows depending on the AF MODE selection.

- **When AF MODE is at PART TIME**
AF movement is ACTIVE, and AF movement continues while the switch is pressed.
- **When AF MODE is at FULL TIME**
AF movement is at HOLD, and focus position is maintained while the switch is pressed.

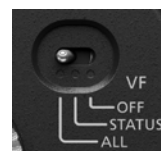

Viewfinder (VF) display change-over switch

This switch lets users select AF frame and focus status display on the viewfinder and provides the following three modes.

- **OFF:** AF frame and focus status are not displayed.
- **STATUS:** Focus status is displayed.
- **ALL:** AF frame and focus status are displayed

Curve Selection and Settings

FDJ-G01

FDJ-S01

FDJ-G01

FDJ-S01

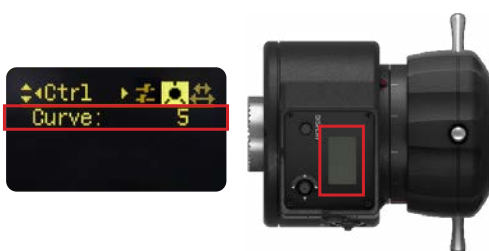

Display Makes Curve Settings Simple and Clear

The nine types² of focus curves in Far and Near modes can be assigned to the curve selector switch easily using the display.

²The initial value is set at 5

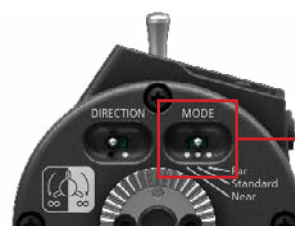

Select using switch on side of main unit

Switch on Side of Unit Makes Selecting Faster

Users can switch between three assigned focus curves depending on usage situation.

DIGITAL UHD-DIGISUPER/DIGISUPER Series

For:
 UHD-DIGISUPER 122 AF / UHD-DIGISUPER 122 / UHD-DIGISUPER 111 / UHD-DIGISUPER 90 / UHD-DIGISUPER 66 /
 UHD-DIGISUPER 27 / DIGISUPER 95 TELE / DIGISUPER 95 / DIGISUPER 80 / DIGISUPER 27

FULL SERVO SYSTEM

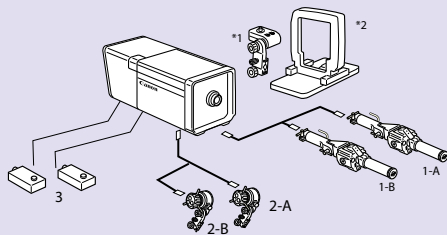

KIT DETAIL

No.	DESCRIPTION
1-A.	Zoom Demand ZDJ-G01 (Digital Servo)
1-B.	Zoom Demand ZDJ-S01 (Digital Servo)
2-A.	Focus Demand FDJ-G01 (Digital Servo)
2-B.	Focus Demand FDJ-S01 (Digital Servo)
3.	Servo Module SMJ-E01 (2pcs)

SEMI-SERVO SYSTEM

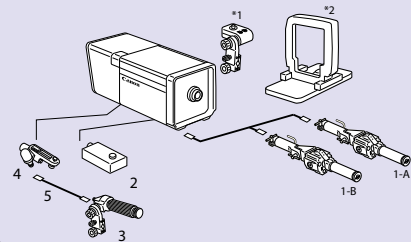

KIT DETAIL

No.	DESCRIPTION
1-A.	Zoom Demand ZDJ-G01 (Digital Servo)
1-B.	Zoom Demand ZDJ-S01 (Digital Servo)
2.	Servo Module SMJ-E01
3.	Flexible Focus Controller FFP-T61
4.	Flexible Module FMJ-702
5.	Flexible Cable 36"

For:
 All UHD-DIGISUPER /
 DIGISUPER Lenses

FULL MANUAL SYSTEM

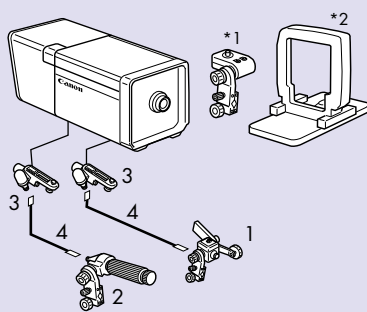

KIT DETAIL

No.	DESCRIPTION
1.	Flexible Zoom Controller FZP-T61
2.	Flexible Focus Controller FFP-T61
3.	Flexible Module FMJ-702 (2pcs)
4.	Flexible Cable 36" (2pcs)

For:
 UHD-DIGISUPER 122/ UHD-DIGISUPER 122 AF
 UHD-DIGISUPER 111

BOKEH EFFECT CONTROLLER

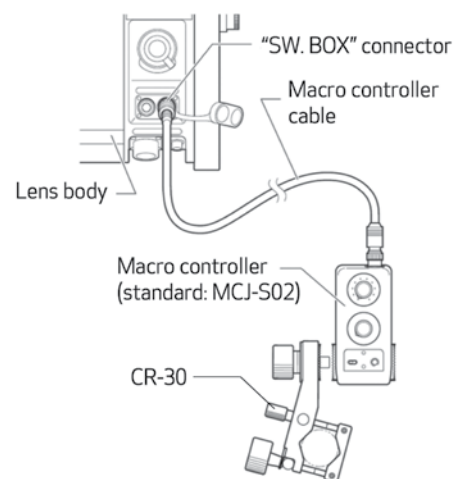

*1: Switch Box is optionally available. The equivalent switches are integrated into Zoom Demands. It is recommended to have the Switch Box with Full Manual System.

*2: Lens Supporter is necessary for portable camera mounting. Some cameras need separate power supply for zoom and focus servo operation.

*3: For DIGISUPER 100AF, DIGISUPER 86AF, and DIGISUPER 27AF, FDJ-P41 is necessary to control the AF function. FDJ-P31 is also available for right hand users.

• Zoom Demand and Focus Demand with Pre-set Box is also available.

• For detail information, please contact a Canon Sales Office.

Studio/Field Lenses Mount Compatibility

To Use Camera Manufacturer's Original Mount Lens

Studio/Field lenses are made with mounts corresponding to each manufacturer's Studio/Field cameras. To make the lenses compatible with Portable Studio/Field Companion cameras, the correct lens Support System must be chosen from the following:

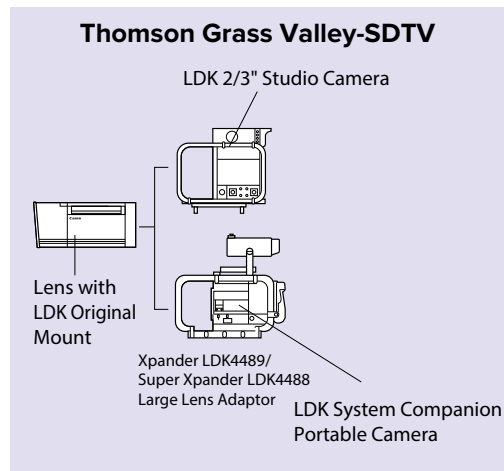
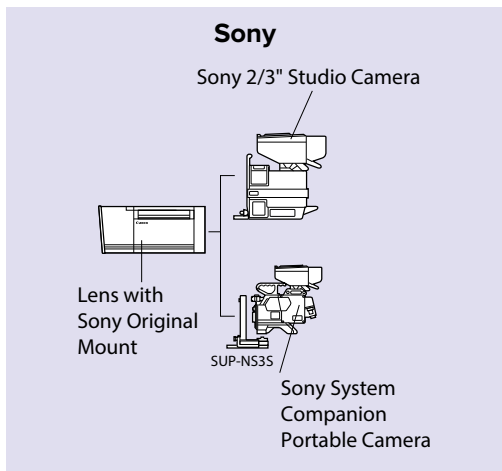
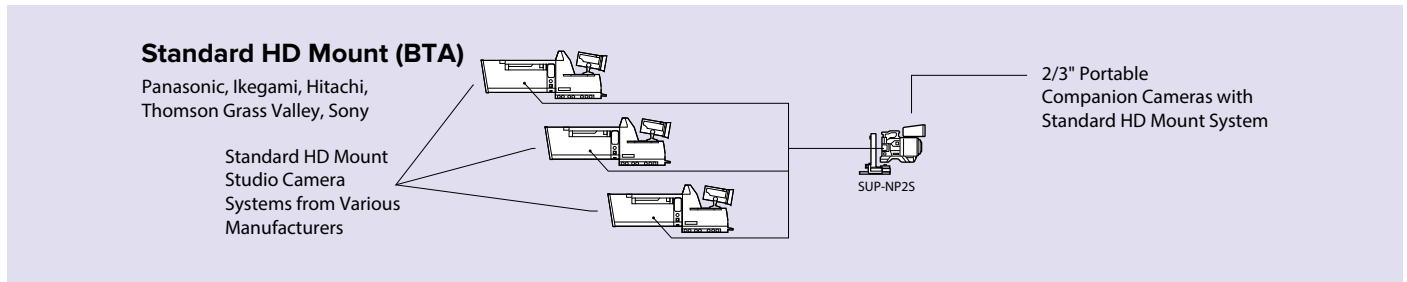

Please confirm with camera manufacturer regarding the proper supporter to use. Some manufacturers vary by camera model.

Broadcast ENG/EFP Lenses

4K UHD 2/3"

	CJ45ex13.6B UHDxs		CJ45ex9.7B UHDxs		CJ25ex7.6B UHDxs	
Appearance						
Model Name	CJ45ex13.6B IASE-V H		CJ45ex9.7B IASE-V H		CJ25ex7.6B IRSE S/IASE S	
Zoom Ratio	45x		45x		25x	
Focal Length	13.6 ~ 612mm	27.2 ~ 1224mm (2.0x)	9.7 ~ 437mm	19.4 ~ 874mm (2.0x)	7.6 ~ 190mm	15.2 ~ 380mm (2.0x)
Maximum Relative Aperture	F1:2.8 (13.6 ~ 312mm) F1:5.5 (612mm)	F1:5.6 (27.2 ~ 624mm) F1:11.0 (1224mm)	F1:2.0 (9.7 ~ 224mm) F1:3.9 (437mm)	F1:4.0 (19.4 ~ 448mm) F1:7.8 (874mm)	F1.8 (7.6 ~ 1108mm) F2.9 (190mm)	F3.6 (15.2 ~ 236mm) F5.8 (380mm)
Angular Field of View	38.9°×22.5° (13.6mm) 0.90°×0.51° (612mm)	20.0°×11.3° (27.2mm) 0.45°×0.25° (1224mm)	52.7°×31.1° (9.7mm) 1.26°×0.71° (437mm)	27.8°×15.8° (19.4mm) 0.63°×0.35° (874mm)	64.6°×39.1° (7.6mm) 2.89°×1.63° (190mm)	35.1°×20.1° (15.2mm) 1.458°×0.81° (380mm)
M.O.D.* from Lens Front	2.8m		2.8m		0.8m	
Object Dimensions at M.O.D.*	182.9×102.9cm (13.6mm) 4.2×2.4cm (612mm)	91.5×51.5cm (27.2mm) 2.1×1.2cm (1224mm)	254.3×143.0cm (9.7mm) 5.8×3.3cm (437mm)	127.2×71.5cm (19.4mm) 2.9×1.7cm (874mm)	93.9×52.8cm (7.6mm) 3.9×2.2cm (190mm)	48.1×27.1cm (15.2mm) 2.0×1.1cm (380mm)
Filter Thread Size (Hood/Lens Barrel)	- / 127mm P0.75		- / 127mm P0.75		105mm P1 / 94mm P1	
Approx. Size (WxHxL)	6.8×5.8×14.0 in. (173.2×147.5×355.0mm)		6.8×5.8×13.3 in. (173.2×147.5×337.0mm)		6.8×4.5×8.8 in. (169.6×114.4×223.3mm)	
Approx. Weight	12.4 lb (5.64kg)		12.3 lbs (5.60kg)		4.4 lb (1.99kg)	

4K UHD 2/3"

	CJ27ex7.3B UHDxs		CJ14ex4.3B UHDGC		CJ15ex4.3B UHDxs	
Appearance						
Model Name	CJ27ex7.3B IASE T		CJ14ex4.3B IRSE S/IASE S		CJ15ex4.3B	
Zoom Ratio	27x		14x		15x	
Focal Length	7.3 ~ 197mm	14.6 ~ 394mm	4.3 ~ 60mm	8.6 ~ 120 mm (2.0x)	4.3 - 65mm	8.6 - 130mm
Maximum Relative Aperture	F1.8 (7.3 ~ 120mm) F2.95 (197mm)	F3.6 (14.6 ~ 240mm) F5.9 (394mm)	F1:1.8 (4.3 ~ 40 mm) F1:2.7 (60mm)	F1:3.6 (8.6 ~ 80mm) F1:5.4 (120mm)	1:1.8 at 4.3 - 40mm 1:2.9 at 65mm	1:3.6 at 8.6 - 80mm 1:5.8 at 130mm
Angular Field of View	66.7°×40.6° (7.3mm) 2.79°×1.57° (197mm)	36.4°×21.0° (14.6mm) 1.40°×0.79° (394mm)	96.3°×64.2° (4.3mm) 9.1°×5.2° (60mm)	58.3°×34.9° (8.6mm) 4.6°×2.6° (120mm)	65.2°×39.6° (7.5mm) 3.1°×1.7° (180mm)	35.5°×20.4° (15mm) 1.5°×0.9° (360mm)
M.O.D.* from Lens Front	0.80m (10 mm with Macro)		0.30m		0.30m	
Object Dimensions at M.O.D.*	98.0×55.1cm (7.3mm) 3.8×2.1cm (197mm)	49.2×27.6cm (14.6mm) 1.9×1.1cm (394mm)	76.4×43.0 cm (4.3mm) 5.2×2.9 cm (60mm)	38.2×21.5 cm (8.6mm) 2.6×1.5 cm (120mm)	76.1 × 42.8cm at 4.3mm 4.9 × 2.8cm at 65mm	38.1 × 21.4cm at 8.6mm 2.5 × 1.4cm at 130mm
Filter Thread Size (Hood/Lens Barrel)	φ 105mm		127mm P0.75 / -		127mm P0.75 / -	
Approx. Size (WxHxL)	6.7×4.6×9.0 in. (169.9×117.2×229.0mm)		6.4×4.3×9.8 in. (163.5×108.0×247.8mm)		163.0 × 107.6 × 249.6mm	
Approx. Weight	4.63 lbs (2.1kg)		4.7 lb (2.11kg, (IRSE S))		2.19kg (IASE S)	

4K UHD 2/3"

	CJ24ex7.5B UHDGC		CJ18ex7.6B UHDGC	
Appearance				
Model Name	CJ24ex7.5B IRSE S/IASE S		CJ18ex7.6B IRSE S/IASE S	
Zoom Ratio	24x		18x	
Focal Length	7.5 ~ 180mm	15.0 ~ 360mm (2.0x)	7.6 ~ 137 mm	15.2 ~ 274 mm (2.0x)
Maximum Relative Aperture	F1:1.8 (7.5 ~ 120mm) F1:2.7 (180mm)	F1:3.6 (15 ~ 240mm) F1:5.4 (360mm)	F1:1.8 (7.6 ~ 103mm) F1:2.4 (137mm)	F1:3.6 (15.2 ~ 206mm) F1:4.8 (274mm)
Angular Field of View	65.2°×39.6° (7.5mm) 3.1°×1.7° (180mm)	35.5°×20.4° (15mm) 1.5°×0.9° (360mm)	64.6°×39.1° (7.6mm) 4.0°×2.3° (137mm)	35.1°×20.1° (15.2mm) 2.0°×1.1° (274mm)
M.O.D.* from Lens Front	0.80m		0.56m	
Object Dimensions at M.O.D.*	96.0×54.0 cm (7.5mm) 4.1×2.3 cm (180mm)	48.0×27.0 cm (15mm) 2.1×1.2 cm (360mm)	65.5×36.8 cm (7.6mm) 3.8×2.1 cm (137mm)	32.8×18.4 cm (15.2mm) 1.9×1.1 cm (274mm)
Filter Thread Size (Hood/Lens Barrel)	105mm P1 / 94mm P1		- / 82mm P0.75	
Approx. Size (WxHxL)	6.5×4.3×8.7 in. (164.6×109.1×221.4mm)		6.3×4.1×8.1 in. (160.5×105.0×206.2mm)	
Approx. Weight	4.0 lb (1.82kg, (IRSE S))		3.3 lb (1.65kg, (IRSE S))	





* M.O.D. = Minimum Object Distance.

Broadcast ENG/EFP Lenses

4K UHD 2/3"

	CJ20e×5B UHD_{XS}		CJ18e×28B UHD_{GC}	
Appearance				
Model Name	CJ20e×5B IASE S		CJ18e×28B IASE S	
Zoom Ratio	20x		18x	
Focal Length	5 ~ 100mm	10 ~ 200mm (2.0x)	28 ~ 500mm	56 ~ 1000mm (2.0x)
Maximum Relative Aperture	F1.8 (5 ~ 61mm) F2.95 (100mm)	F3.6 (10 ~ 122mm) F5.9 (200mm)	F2.8 (28 ~ 286mm) F4.9 (500mm)	F5.6 (56 ~ 572mm) F9.8 (1000mm)
Angular Field of View	87.7°×56.7° (5mm) 5.5°×3.1° (100mm)	51.3°×30.2° (10mm) 2.7°×1.5° (200mm)	19.5°×11.0° (28mm) 1.10°×0.62° (500mm)	9.8°×5.5° (56mm) 0.55°×0.31° (1000mm)
M.O.D.* from Lens Front	0.4m		2.2m	
Object Dimensions at M.O.D.*	87.1×49.0cm (5mm) 4.2×2.4cm (100mm)	43.6×24.5cm (10mm) 2.1×1.2cm (200mm)	71.0×39.9cm (28mm) 4.1×2.3cm (500mm)	35.5×20.0cm (56mm) 2.1×1.2cm (1000mm)
Filter Thread Size (Hood/Lens Barrel)	127mm P0.75 / -			
Approx. Size (WxHxL)	6.5x4.4x9.9 in. (166.3x110.8x251.7mm)		7.0x4.8x10.6 in. (177.8x122.5x268.3mm)	
Approx. Weight	4.94 lbs (2.24kg (IASE S))		6.08 lb (2.76kg (IASE S))	

HD 2/3"

	HJ40e×14B HD_{XS}		HJ40e×10B HD_{XS}	
Appearance				
Model Name	HJ40e×14B IASE-V H		HJ40e×10B IASE-V H	
Zoom Ratio	40x		40x	
Focal Length	14 ~ 560mm	28 ~ 1120mm (2.0x)	10 ~ 400mm	20 ~ 800mm (2.0x)
Maximum Relative Aperture	F2.8 (14 ~ 307mm) F5.1 (560mm)	F5.6 (28 ~ 614mm) F10.2 (1120mm)	F2.0 (10 ~ 220mm) F3.65 (400mm)	F4.0 (20 ~ 440mm) F7.3 (800mm)
Angular Field of View	37.8°×21.8° (14mm) 1.0°×0.6° (560mm)	19.4°×11.0° (28mm) 0.5°×0.3° (1120mm)	51.3°×30.2° (10mm) 1.4°×0.8° (400mm)	27.0°×15.4° (20mm) 0.7°×0.4° (800mm)
M.O.D.* from Lens Front	2.8m		2.8m	
Object Dimensions at M.O.D.*	177.1×99.5cm (14mm) 4.5×2.5cm (560mm)	88.6×49.8cm (28mm) 2.3×1.3cm (1120mm)	248.4×139.7cm (10mm) 6.2×3.5cm (400mm)	124.2×69.9cm (20mm) 3.1×1.8cm (800mm)
Filter Thread Size (Hood/Lens Barrel)	— / 127mm P0.75			
Approx. Size (WxHxL)	6.6x5.2x14 in. (167.5x133.0x355.5mm)		6.6x5.2x13.2 in. (167.5x133.0x335.4mm)	
Approx. Weight	12.2 lbs (5.55 kg)		12.1 lbs (5.5 kg)	

* M.O.D. = Minimum Object Distance.

Broadcast ENG/EFP Lenses

HD 2/3"

	KJ22ex7.6B 		KJ17ex7.7B 		KJ10ex4.5B 	
Appearance						
Model Name	KJ22ex7.6B IRSE S/IASE S		KJ17ex7.7B IRSE S/IASE S		KJ10ex4.5B IRSE S/IASE S	
Zoom Ratio	22x		17x		10x	
Focal Length	7.6-168mm	15.2-336mm (2.0x)	7.7-131mm	15.4-262mm (2.0x)	4.5-45mm	9-90mm (2.0x)
Maximum Relative Aperture	1:1.8 at 7.6-116.3mm 1:2.6 at 168mm	1:3.6 at 15.2-232.6mm 1:5.2 at 336mm (2.0x)	1:1.8 at 7.7-102.5mm 1:2.3 at 131mm	1:3.6 at 15.4-205mm 1:4.6 at 262mm	1:1.8 at 4.5-34.5mm 1:2.35 at 45mm	1:3.6 at 9-68.9mm 1:4.7 at 90mm
Angular Field of View	64.6°x39.1° at 7.6mm 3.3°x1.8° at 168mm	35.1°x20.1° at 15.2mm 1.6°x0.9° at 336mm	63.9°x38.6° at 7.7mm 4.2°x2.36° at 131mm	34.6°x19.9° at 15.4mm 2.1°x1.18° at 262mm	93.7°x61.9° at 4.5mm 12.2°x6.9° at 45mm	56.1°x33.4° at 9mm 6.1°x3.4° at 90mm
M.O.D.* from Lens Front	0.8m		0.6m		0.3m	
Object Dimensions at M.O.D.*	95.0x53.4cm at 7.6mm 4.4x2.5cm at 168mm	47.5x26.7cm at 15.2mm 2.2x1.3cm at 336mm	68.5x38.5cm at 7.7mm 4.2x2.4cm at 131mm	34.3x19.3cm at 15.4mm 2.1x1.2cm at 262mm	74.1x41.7cm at 4.5mm 6.4x3.6cm at 45mm	37.0x20.8cm at 9mm 3.2x1.8cm at 90mm
Filter Thread Size (Hood/Lens Barrel)	105mm P1 / 94mm P1		— / 82mm P0.75		127mm P0.75 / —	
Approx. Size (WxHxL)	6.5x4.4x8.6 in. (164.7x111.8x218.6mm)		6.3x4.2x7.8 in. (159.3x106.6x197.8mm)		6.6x4.4x9.4 in. (168.2x111.8x237.7mm)	
Approx. Weight (IRSE/IASE)	4.0 lbs (1.82kg)/4.19 lbs (1.90kg)		3.26 lbs (1.48kg)/3.44 lbs (1.56kg)		4.04 lbs (1.83kg)/4.22 lbs (1.91kg)	

Broadcast ENG/EFP, Pro Video Lens Optical Accessories

Adaptor Type Converters/Attachments

CATEGORY	MODEL	CJ45e×13.6B CJ45e×9.7B	CJ14e×4.3B CJ15e×4.3B CJ18e×8.5BB CJ18e×28B CJ20e×5B KJ10e×4.5B HJ40e×14B HJ40e×10B	KJ13×6B	CJ27e×7.3B CJ25e×7.6B CJ24e×7.5B KJ22e×7.6B	CJ18e×7.6B KJ20×8.2B KT17e×4.3B KJ17e×7.7B KH20×6.4
WIDE ATTACHMENT *1	WA75HG				●	●
ADAPTER RING	ACC-85 III					●
	ACC-98 II				●	
CLOSE-UP LENS	82CL-UP800H					● *2
	82CL-UP1300H					● *2
	105CL-UP800HG				●	
UV FILTER	UV / 82					●
	UV / 94				●	
	UV / 105			●	●	
	UV / 127	●	●			
CLEAR FILTER	CL/127	●	●			
POLARIZATION FILTER	PL / 82					●
	PL / 105			●	●	
	PL / 127		●			

*1: An adaptor ring is necessary to attach it to the lens. *2: Close-up lens supported for SD.



• The number of each filter type name, indicates the screw diameter. Screw pitch: screw diameter 82 mm = 0.75 mm, thread diameter 127 mm = 0.75 mm, thread diameter other than the left = 1.00 mm

The following items have been discontinued: W80H Wide Converter.

The following lenses have been discontinued: HJ18e×28B, HJ24e×7.5B, HJ18e×7.6B, HJ14e×4.3B, KH13×4.5B

Mount Converters for Different Image Format Size Cameras

Canon offers a variety of Mount Converters to be used between a lens and a camera of different image format sizes. Each converter will extend the effective Angular Field of View of the associated lens according to the Shift Ratio listed below.

	Converter	Image Size Conversion			Electronic Conversion
		Lens*4	Camera	Shift Ratio to Telephoto Side	
	LO-32BMT	2/3" B4 Mount	1/2" Sony*5	Approx. 1.4x	N/A
	LCV-40B	2/3" B4 Mount	1/2 Standard Mount*6	Approx. 1.4x	N/A
	LCV-42T	2/3" B4 Mount	1/3" Standard Mount	Approx. 1.8x	N/A
	LCV-41E	2/3" B4 Mount	Sony PMW-EX3	Approx. 1.4x	Lens Cable (12 pin) EX3 Hot Shoe (14 pin)

*4: The converters are to be used with lenses weighing less than 4.4 lbs (2.0kg). *5: Sony's Hot Shoe mount camera, excluding PMW-EX3.

*6: 1/2" Camera of standard type mount (Panasonic, JVC, Grass Valley).

Converter/Attachments

TELE-SIDE CONVERTER



- The use of the telephoto converter would shift the focal length of a lens with a factor of 1.5x.
- F No. of the original lens is not affected.
- Only the telephoto side of the lens can be used. The picture corners are eclipsed at wide angle.
- The minimum object distance becomes 2.25x that of the original lens.

CHANGE IN FOCAL LENGTH

Model	M.O.D.	Eclipse Point
CJ24ex7.5B	1.8m	f:100mm
KJ17ex7.7B	1.35m	f:60mm

WIDE CONVERTER



- The wide converter W80/W80Y-85 would shift the focal length of a lens with a factor of 0.8x.
- F No. of the original lens is not affected.
- The minimum object distance becomes 0.64x with the W80/W80Y-85.

CHANGE IN FOCAL LENGTH

Model	Master Lens	With Wide Converter
CJ24ex7.5B	7.5-180mm	6.0-144mm
KJ17ex7.7B	7.7-131mm	6.2-104.8mm

FISH-EYE ATTACHMENT



- The zoom lens becomes a fish-eye fixed focal length lens (distorted image) with the fish-eye attachment.
- The use of a fish-eye attachment would shift the focal length of a lens with a factor of 0.6x.
- Focus is adjusted by use of the macro lever.

CHANGE IN FOCAL LENGTH

Model	Master Lens	With Fish-Eye Attachment
CJ24ex7.5B	7.5-180mm	4.5mm
KJ17ex7.7B	7.7-131mm	4.6mm

WIDE ATTACHMENT



- The zoom lens becomes a wider fixed focal length lens with the wide attachment.
- The use of the wide attachment would shift the focal length of a lens with a factor of 0.75x.
- Focus is adjusted by use of the macro lever.

CHANGE IN FOCAL LENGTH

Model	Master Lens	With Wide Attachment
CJ24ex7.5B	7.5-180mm	5.6mm
KJ17ex7.7B	7.7-131mm	5.8mm

POLARIZED LIGHT FILTER



- Used to intercept light reflected from the surface of water or glass.
- The polarizer is threaded on to a lens hood.

Extenders



- The X2.0-B4 extender mounts in between a camera and lens to magnify an image.
- The extender doubles the focal length of the master lens and doubles the F-number.

Model	Applicable Lenses
X2.0-B4	Applicable to all B4 type mount Canon 2/3" lenses.

Broadcast ENG/EFP, Pro Video Lens Optical Accessories

Close-Up Lenses



- A close-up lens is used to shorten the M.O.D.* of the master lens for close-up shooting.
- The maximum object distance becomes the focal length of the close-up lens.
- The minimum object distance is calculated by the following formula:

$$\text{New minimum object distance} = fc \times S / (fc + S)$$

$$fc = \text{Focal length of the close-up lens}$$

$$S = \text{M.O.D.* of the master lens}$$

Imaging range for KJ17ex7.7B with close-up lenses

KJ17ex7.7B (16:9)	82CL-UP800H				82CL-UP1300H				
		Tele end : 131mm		Wide end : 7.7mm		Tele end : 131mm		Wide end : 7.7mm	
	Focusing Scale (mm)	∞	0.6	∞	0.6	∞	0.6	∞	0.6
	Object Distance (mm)	800	343	800	343	1300	411	1300	411
	Object Dimensions (mm)	58x33	24x14	989x556	376x212	95x53	29x16	1634x919	455x256

Model	Applicable Lenses
82CL-UP800H ^{*1}	HJ18ex7.6B, HJ15ex8.5B, KJ17ex7.7B, KJ20x8.2B, KH20x6.4, KT17ex4.3B, KT20x5
82CL-UP1300H ^{*1}	HJ18ex7.6B, HJ15ex8.5B, KJ17ex7.7B, KJ20x8.2B, KH20x6.4, KT17ex4.3B, KT20x5
105CL-UP900H ^{*1}	HJ24ex7.5B, KJ22ex7.6B
105CL-UP800HG	CJ20ex7.8B, CJ24ex7.5B, HJ24ex7.5B, KJ22ex7.6B

*M.O.D. = Minimum Object Distance.
^{*1}: Not recommended for 4K shooting.

Broadcast ENG/EFP, Pro Video Lens Accessories

Compatible Zoom/Focus Control List

OPERATION	CATEGORY	MODEL	CJ45ex13.6B CJ45ex9.7B HJ40ex14B HJ40ex10B	CJ27ex7.3B CJ14ex4.3B CJ15ex4.3B CJ18ex7.6B CJ18ex28B CJ20ex5B CJ24ex7.5B CJ25ex7.6B	KJ10ex4.5B KT17ex4.3B KJ17ex7.7B KJ22ex7.6B	KJ20x8.2B KJ13x6B KH20x6.4
FOCUS	FOCUS DEMAND	FPD-400D	●	●	●	● ^{*1}
		FDJ-S31/41	●	●	●	
	DRIVE UNIT	FPM-77				●
		FPM-420D			● (IRS,KRS)	
	FLEX CONTROLLER	FFC-200	● ^{*3}		● ^{*2}	●
		FFC-15				●
	FLEXIBLE CABLE (32 INCHES)	FC-40	● ^{*3}		● ^{*2}	●
	OUTLET	FFM-100			● ^{*2}	
FM-12					●	
FFM-300		● ^{*3}				
ZOOM	ZOOM DEMAND	ZSD-300D	●	●	●	● ^{*1}
	PROVIDEO ZOOM	ZSD-15MII				●
	SERVO GRIP	ZSG-200M	● ^{*1}	● ^{*1}	●	●

* 1: A unit that can be attached using a conversion cable.
^{* 2}: Please be aware use of these controllers will result in a lower image quality MTF.
^{* 3}: These accessories are not recommended for use with CJ45ex9.7B and CJ45ex13.6B.

Broadcast ENG/EFP, Pro Video Lens Optical Accessories

Focus Controller



Focus Controller



Zoom Controller



■ Conversion Cable is Necessary When Using with the Following Combinations

Model Name	Applicable Lens	Adapter Cable	Lens Side Pin#	Control Side Pin#
FPM-420D	Analog Drive Lens	CC-1220	12	20
FPD-400D		CC-0620	6	20
ZSD-300D		CC-0820	8	20

Control Accessories for Digital Drive ENG/EFP Lenses

CJ45ex13.6B / CJ45ex9.7B / CJ25ex7.6B / CJ20ex7.8B / CJ12ex4.3B / CJ18ex28B / CJ15ex8.5B / CJ24ex7.5B / CJ18ex7.6B / CJ14ex4.3B / HJ40ex14B / HJ40ex10B / KJ22ex7.6B / KJ17ex7.7B / KJ10ex7.5B / KT17ex4.3B

Recommended Kit Configurations

MS-210D SEMI-SERVO KIT

for all listed IASE S/IRSE S/KRSE S Lenses

The diagram illustrates the MS-210D SEMI-SERVO KIT. It includes a lens, a control unit (FFM-100), a cable (FC-40), a servo motor (FFC-200), and a lens mount (ZSD-300D). Lines connect the components to show their assembly and connection points.

SS-41-D FULL SERVO KIT

for all listed IRSE S/KRSE S Lenses

The diagram illustrates the SS-41-D FULL SERVO KIT. It includes a lens, a control unit (FPM-420D), a servo motor (FPD-400D), and a lens mount (ZSD-300D). Lines connect the components to show their assembly and connection points.

SS-41-IASD FULL SERVO KIT

for all listed IASE S Lenses

The diagram illustrates the SS-41-IASD FULL SERVO KIT. It includes a lens, a servo motor (FPD-400D), and a lens mount (ZSD-300D). Lines connect the components to show their assembly and connection points.

SS-42-IAS FULL SERVO KIT

for all listed IASE S Lenses

The diagram illustrates the SS-42-IAS FULL SERVO KIT. It includes a lens, a servo motor (FPD-400D), a control unit (EC-80), a cable (CC-2008), a servo motor (CR-10), and a lens mount (ZSG-200M). Lines connect the components to show their assembly and connection points.

DIGITAL Control Accessories of Digital Drive ENG/EFP Lenses

Applicable Component Detail

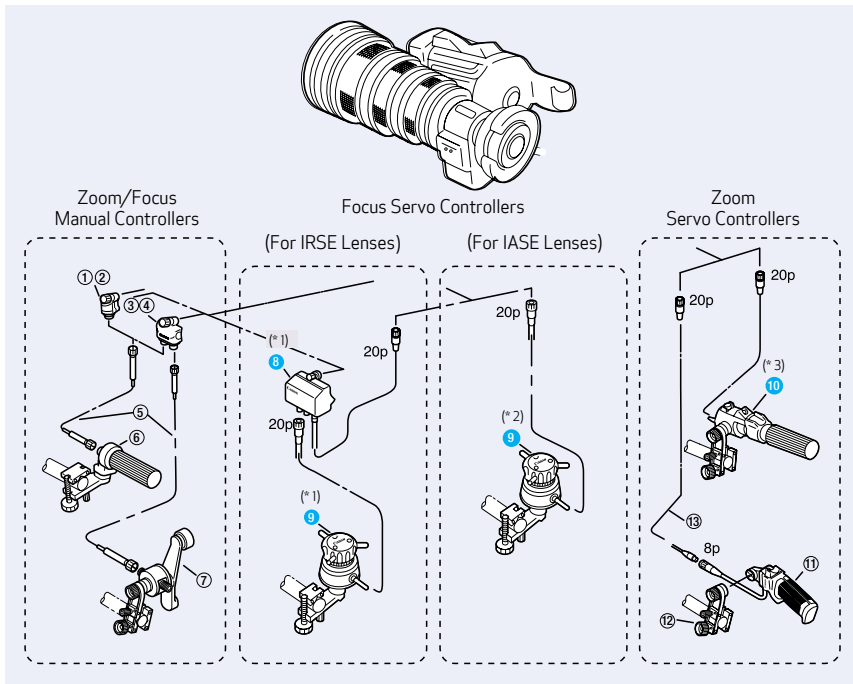

#	UNIT	DESCRIPTION
①	FFM-100	Flex Focus Module
②	FFM-300	Flex Focus Module
③	FFM-200 ^{*1}	Flex Dual Module
④	FFM-400 ^{*1,2}	Flex Dual Module
⑤	FC-40	Flex Cable
⑥	FFC-200	Flex Focus Controller
⑦	FZC-100 ^{*1}	Flex Zoom Controller
⑧	FPM-420D ^{*1}	Focus Positional Servo Module
⑨	FPD-400D ^{*1}	Focus Positional Demand
⑩	ZSD-300D ^{*1}	Zoom Demand
⑪	ZSG-200M	Zoom Servo Grip
⑫	CR-10	Clamper
⑬	CC-2008	20p-8p Cable

*1: FZC-100, FFM-200, FFM-400, FPD-400, FPM-420 and ZSD-300A/M are discontinued.

*2: Analog FPD-400 is also applicable, however, CC-2006 conversion cable is necessary to connect between IASD/IASE Digital Drive Lens and FPD-400.

*3: Analog ZSD-300A/M is also applicable but CC-2008 is needed to connect between IASE S digital drive lens and ZSD-300A/M.

● The controllers support the new DD functions.

Applicable Kit Detail

For IRSE S Type Lenses

	Kit Name	Zoom		Focus	
		System	Component	System	Component
Zoom Servo Only	(ZR-1D)	ZR-1D	20	—	—
	—	ZR-2(A)	21, 22, 28	—	—
Semi-Servo	MS-210D	ZR-1D	20	FR-2	2, 8, 10
	MS-220	ZR-2(A)	21, 22, 28	FR-2	2, 8, 10
Full Servo	SS-41-D	ZR-1D	20	FPS-4D	13, 17
Full Manual	—	FZC-1	6, 8, 11	FR-2 (w/o 2)	8, 10

For IASE S Type Lenses (Except HJ40ex, CJ45ex)

	Kit Name	Zoom		Focus	
		System	Component	System	Component
Zoom Servo Only	(ZR-1D)	ZR-1D	20	—	—
	—	ZR-2(A)	21, 22, 28	—	—
Semi-Servo	MS-210D	ZR-1D	20	FR-2	2, 8, 10
	MS-220	ZR-2(A)	21, 22, 28	FR-2	2, 8, 10
Full Servo	SS-41-IASD	ZR-1D	20	FPS-4D	17
	SS-42-IASD	ZR-2(A)	21, 22, 28	FPS-4D	17
Full Manual	—	FZC-1	6, 8, 11	FR-2 (w/o 2)	8, 10

For CJ45ex13.6B, CJ45ex9.7B, HJ40ex14B and HJ40ex10B

	Kit Name	Zoom		Focus	
		System	Component	System	Component
Zoom Servo Only	—	ZR-1D	20	—	—
	—	ZR-2(A)	21, 22, 28	—	—
Semi-Servo	—	ZR-1D	20	FR-2	3, 8, 10
	—	ZR-2(A)	21, 22, 28	FR-2	3, 8, 10
Full Servo	SS-41-IASD	ZR-1D	20	FPS-4D	17
	SS-42-IASD	ZR-2(A)	21, 22, 28	FPS-4D	17
Full Manual	—	FZC-1	6, 8, 11	FR-2 (w/o 2)	8, 10

■ Recommended kit configuration.

ANALOG Control Accessories for Analog Drive HDgc Lenses

Recommended Kit Configuration

MS-15 SEMI-SERVO KIT

for all Pro-video ENG lenses

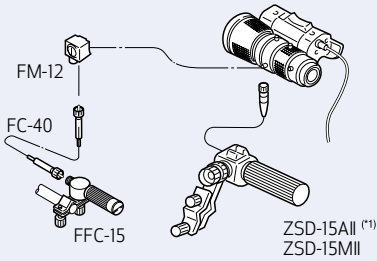

MS-22 SEMI-SERVO KIT

for all Pro-video ENG lenses

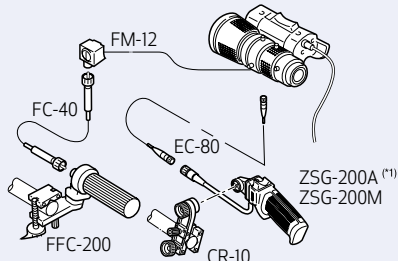

MS-21D SEMI-SERVO KIT

for all Pro-video ENG lenses

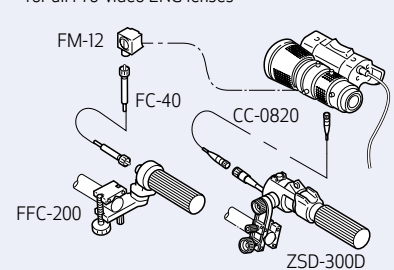

*1: "A" or "M" type demands depend upon camera. Type "A" demands are no longer available from Canon.

Applicable Component Detail

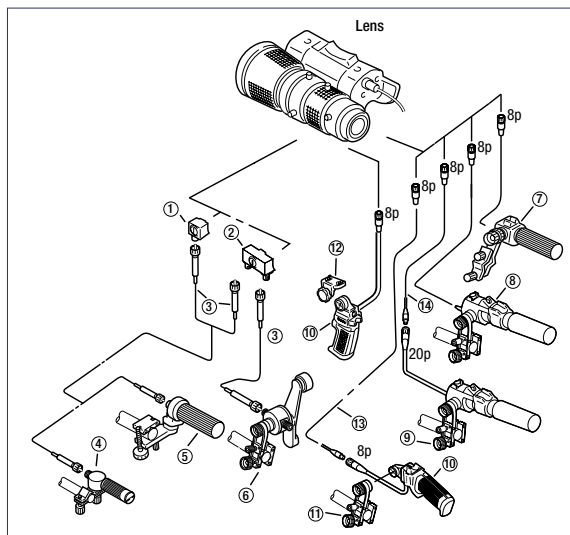

#	UNIT	DESCRIPTION
①	FM-12	Flex Focus Module
②	FM-70*	Flex Dual Module
③	FC-40	Flex Cable
④	FFC-15	Flex Focus Controller
⑤	FFC-200	Flex Focus Controller
⑥	FZC-100*	Flex Zoom Controller
⑦	ZSD-15A II / M II Zoom Demand ²	A (A or M types, depends on applicable camera) M
⑧	ZSD-300A/M Zoom Demand ²	A (A or M types, depends on applicable camera) M
⑨	ZSD-300D	Zoom Demand
⑩	ZSG-200A/M Zoom Servo Grip ²	A (A or M types, depends on applicable camera) M
⑪	CR-10	Clamper
⑫	GA-70*	Grip Adapter
⑬	EC-80	Zoom Extension Cable (8P)
⑭	CC-0820	Conv. Cable (8pM-20pF)

*FM-70, FZC-100, and GA-70 are discontinued.

*2: ZSD-15A II, ZSD-300A/M, ZSG-200A, and FPD-400 are no longer available from Canon stock.

Applicable Kit Detail

Kit Name	Zoom		Focus		
	System	Component	System	Component	
Zoom Servo Only	—	ZSD-15	16	—	
	—	ZR-1	17	—	
	—	ZR-2(A)	19, 20, 26	—	
	—	ZR-2(B)	19, 21*	—	
Semi-Servo	MS-15	ZSD-15	16**	FRC-15	1, 8, 9**
	MS-21	ZR-1	17	FR-2	1, 8, 10
	MS-21D	ZR-1D	18, 28	FR-2	1, 8, 10
	MS-22	ZR-2(A)	19, 20, 26	FR-2	1, 8, 10
Full Manual	FZC-1	FZC-1	5*, 8, 11	FR-2(w/o 1)	8, 10

*② & ⑫ are not applicable to YH14x7.3 and YH16x7.

**In USA, ⑦ and ④ are available only as MS-15 kit configuration and not as individual products.

Recommended kit configuration.

CINEMA LENS LINEUP



CINE-SERVO Series

Canon Cine-Servo Lenses support cinema production as well as 4K content creation for broadcast. Featuring a servo drive unit, they can be ideal for shooting scenarios where speed and mobility are key. Covering an extreme range of 17mm-1000mm with three lenses, the Cine-Servo series are designed for the most demanding use cases.



SUMIRE PRIME Series

Canon is introducing a new line of cinema prime lenses named “Sumire Prime” (pronounced “Soo-mee-ray”) - associated with a floral gentleness and beauty. A unique optical design introduces a nuanced look as the lens aperture approaches its maximum setting - subtly modifying the textural renderings of the human facial close-up. It also smooths the transition to the fall-off portions of the scene resulting in a pleasing bokeh. This combination adds emotional expressiveness to a memorable scene.



PRIME Series

The new lenses—Canon’s first cinema lenses equipped with its RF mount—combine high optical performance for 4K and 8K shooting, cinema-style operability, and RF mount transmission functionality. With these RF Cinema Lenses, Canon will expand its lineup of RF-mount-compatible video production equipment to meet the needs of professional video production such as movies, TV and commercials.



FLEX ZOOM LENS

The Full-Frame compatible Cinema Lens series offers T2.4 with a large aperture ratio. These lenses increase the expressive range in depth of field while carrying on the operability of Cinema Style.



COMPACT-SERVO Series

The Compact-Servo series of lenses are aimed at users looking for the benefits of a cinema lens in a smaller and lighter package. Featuring cinema lens advantages such as stepless iris and geared focus rings, they are capable of high image quality in a smaller housing.

FLEX ZOOM Lens Series

➔ P. 39

NEW



CN-E20-50mm T2.4 L F
CN-E20-50mm T2.4 L FP

NEW



CN-E14-35mm T1.7 L S
CN-E14-35mm T1.7 L SP

NEW



CN-E45-135mm T2.4 L F
CN-E45-135mm T2.4 L FP

NEW



CN-E31.5-95mm T1.7 L S
CN-E31.5-95mm T1.7 L SP

SUMIRE PRIME Lens Series

➔ P. 40



CN-E14mm T3.1 FP X CN-E20mm T1.5 FP X CN-E24mm T1.5 FP X CN-E35mm T1.5 FP X CN-E50mm T1.3 FP X CN-E85mm T1.3 FP X CN-E135mm T2.2 FP X

PRIME Lens Series

➔ P. 40



CN-R14mm T3.1 L F CN-R20mm T1.5 L F CN-R24mm T1.5 L F CN-R35mm T1.5 L F CN-R50mm T1.3a L F CN-R85mm T1.3 L F CN-R135mm T2.2 L F

CINE-SERVO Lens Series

➔ P. 41



CN7 X 17 KAS T/RF
CN7 X 17 KAS T/PL



CN10x25 IAS S/E1
CN10x25 IAS S/P1



CN8x15 IAS S/E1
CN8x15 IAS S/P1



CN20x50 IAS H/E1
CN20x50 IAS H/P1

COMPACT-SERVO Lens Series

➔ P. 42



CN-E18-80mm T4.4 L IS KAS S



CN-E70-200mm T4.4 L IS KAS S



ZSG-C10

MEETING THE DEMANDS OF THE 4K ERA

Canon Cinema Lens Technology

Optical Performance

Crystal Clear Canon Optical Technology

Super 35mm,* High quality 4K/HDR

From the center to the periphery of the image, Canon's cinema lenses achieve a high quality 4K HDR image with both our prime and zoom lenses. Canon's optical technologies are combined to help correct various aberrations and provide high contrast while achieving a high resolution of about 80 lines/mm throughout the entire range of our cinema lenses.

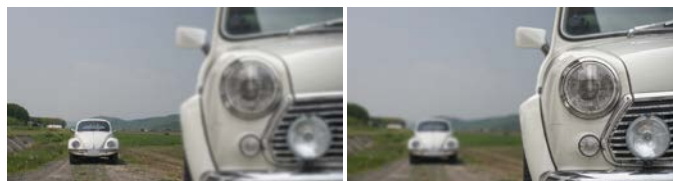

11 Blade Aperture

Halos from points of light at night or from rays of sunlight in shots that show the sun take on the shape of the Iris blades. The odd number of blades make the iris aperture look circular even when the Iris is contracted, enabling beautiful, round highlight bokeh.

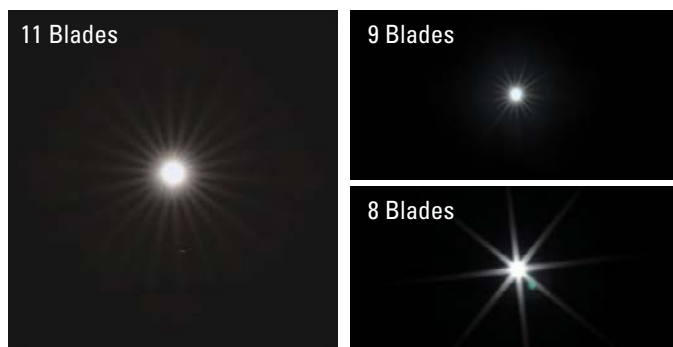

Warm Color Balance

Cinema lens color balance, ideal for movie production, reproduces warm skin tones. Color balance is strictly uniform across all Canon cinema lenses making lens substitution during the same scene possible. Anti-reflection film technology, including super spectral coatings and thorough corrections for slight color variations caused by glass components allow Canon lenses to achieve this effect.

Flange Back Adjustment

A flange back adjustment mechanism is installed on the lens mounts to allow for back focus adjustments.



Focus Breathing Suppression

Focus breathing is caused when the focus group moves and exerts a "zooming" effect. In order to prevent this, cinema lenses implement a 3-group inner focus method and a new floating method to help minimize field angle fluctuation and achieve stable framing.

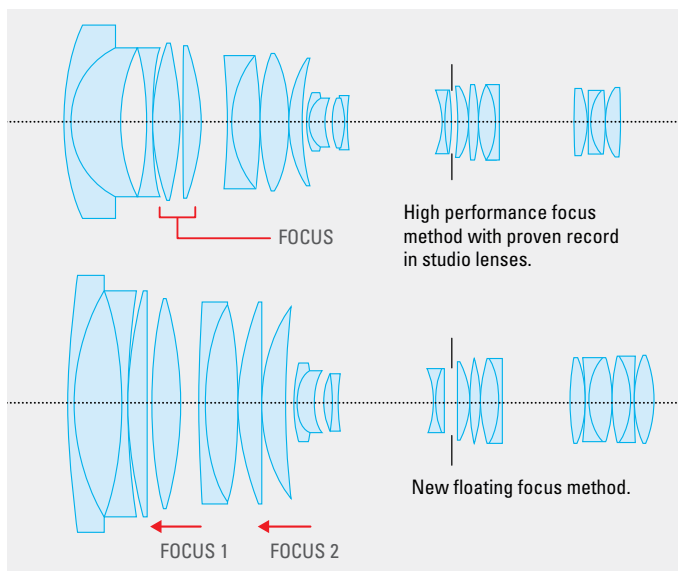

* Excluding PRIME Lens series.

■ Luminous Focus Markings

The Focus Scale on the front lens barrels is printed with luminescent paint to improve visibility at night and in dark studio conditions.



Dust/Splash Resistant Seals and Casing*

Our CN-E EF prime and Sumire Prime lenses use dust and splash resistant rubber gaskets at the casing joints.

** Lenses are not designed to be submersible in water or exposed to heavy rain.*



■ Changeable Lens Mount

To adapt to the ever-changing requirements of content producers, Canon offers lens mount changing services for applicable lenses at our service centers. Kindly contact your friendly Canon representative for further details.

Focal Length Table

FLEX ZOOM Lenses									
Angle of view horizontal (1.78:1)*1	83.5°		43.3°		53.4°		25.2°		
Focal Distance (mm)	14	20	31.5	35	45	50	95	135	
CN-E14-35mm T1.7 L S	[Red bar from 14 to 35 mm]								
CN-E14-35mm T1.7 L SP	[Red bar from 14 to 35 mm]								
CN-E31.5-95mm T1.7 L S	[Red bar from 31.5 to 95 mm]								
CN-E31.5-95mm T1.7 L SP	[Red bar from 31.5 to 95 mm]								
CN-E20-50mm T2.4 L F	[Red bar from 20 to 50 mm]								
CN-E20-50mm T2.4 L FP	[Red bar from 20 to 50 mm]								
CN-E45-135mm T2.4 L F	[Red bar from 45 to 135 mm]								
CN-E45-135mm T2.4 L FP	[Red bar from 45 to 135 mm]								
SUMIRE PRIME Lenses									
Angle of view horizontal (1.78:1)*2	82.6°	63.2°	54.3°	38.7°	27.6°	16.5°	10.4°		
Focal Distance (mm)	14	20	24	35	50	85	135		
CN-E14mm T3.1 FP X	●								
CN-E20mm T1.5 FP X		●							
CN-E24mm T1.5 FP X			●						
CN-E35mm T1.5 FP X				●					
CN-E50mm T1.3 FP X					●				
CN-E85mm T1.3 FP X						●			
CN-E135mm T2.2 FP X							●		
PRIME Lenses									
Angle of view horizontal (1.78:1)*2	82.6°	63.2°	54.3°	38.7°	27.6°	16.5°	10.4°		
Focal Distance (mm)	14	20	24	35	50	85	135		
CN-R14mm T3.1 L F	●								
CN-R20mm T1.5 L F		●							
CN-R24mm T1.5 L F			●						
CN-R35mm T1.5 L F				●					
CN-R50mm T1.3 L F					●				
CN-R85mm T1.3 L F						●			
CN-R135mm T2.2 L F							●		
CINE-SERVO Lenses									
Angle of view horizontal (1.78:1)*2	71.8°	27.6°	11.7°		1.4°				
Focal Distance (mm)	15	17	25	50	120	250	1000		
CN7x17 KAS T	[Red bar from 15 to 17 mm]								
CN8x15 IAS S	[Red bar from 15 to 17 mm]								
CN10x25 IAS S	[Red bar from 25 to 250 mm]								
CN20x50 IAS H	[Red bar from 50 to 1000 mm]								
COMPACT-SERVO Lenses									
Angle of view horizontal (1.78:1)*2	68.7°		19.9°	17.5°		7.0°			
Focal Distance (mm)	18		70	80		200			
CN-E70-200mm T4.4 L IS KAS S	[Red bar from 70 to 200 mm]								
CN-E18-80mm T4.4 L IS KAS S	[Red bar from 18 to 80 mm]								

*1: When the screen size is 24.0 × 13.5 mm. *2: When the screen size is 24.6 × 13.8 mm.

Sumire Prime



Nuanced Skin
Tone Rendition

Smooth
Bokeh

Canon's Sumire Prime lenses offer a unique look in the Canon Cinema lens family on top of a native PL Mount. In addition to bright T-stops and Canon's renowned warm imagery, a unique optical design introduces a nuanced look as the lens aperture approaches its maximum setting - subtly modifying the textural renderings of the human facial close-up. It also smooths the transition to the fall-off portions of the scene resulting in a pleasing bokeh. This combination adds emotional expressiveness to a memorable scene.



PL MOUNT

CN-E14mm	T3.1	FP	X
CN-E20mm	T1.5	FP	X
CN-E24mm	T1.5	FP	X
CN-E35mm	T1.5	FP	X
CN-E50mm	T1.3	FP	X
CN-E85mm	T1.3	FP	X
CN-E135mm	T2.2	FP	X

SUMIRE PRIME Lens Series: Highlights

Covers Full-frame, Super 35mm and APS-C Sensors

Sumire Primes cover the image circles of Large Format 35mm sensors, significantly increasing their ability to be paired with different cameras to achieve aesthetics that content creators desire.

Phosphorescent Indicators

To improve visibility in nighttime and dark area shooting, indicator markings with phosphorescent paint have been adopted for the front barrel (for right-side viewing).

Artistically Pleasing Image Rendering And Warm Colors

The original lens composition with large diameter aspheric lens and anomalous dispersion glass offers more solid and artistically pleasing image rendering. This brings out the impressive image quality of 4K cinema images in all their glory. And the warm color tones have been made consistent throughout the series to artistically pleasing capture people's facial expressions and enable better depiction of the subject's texture.

Minimized Focus Breathing

The lens controls focus breathing, which realizes stability in images even when bokeh effects occur due to refocusing.

Unified Front Lens Diameter, Gear Position

Compact Zoom and Prime lenses have the same front lens diameter and consistent gear positions, so lenses within each series can be switched without adjusting the rig setup.

Sumire Prime Lens Series

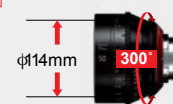

11-Blade Iris

With the increased number of iris blades, users can get natural bokeh that appears more circular, from maximum to minimum aperture. The use of an odd number of blades diffuses light rays in high-brightness subjects and renders images more artistically pleasing.

PL Mount

PL mounts, which are in high demand in the cinema market, have been adopted to support a variety of cameras used in this market.

Soft, Natural Bokeh Effects

The bright T-number of the Prime lens and multi-blade iris diaphragm produce natural blur effects closer to a circle, from maximum to minimum aperture. This enables more three-dimensional bokeh even with super wide angle lenses that have deeper depth of field, broadening the range of visual expression.



FLEX ZOOM LENS: HIGHLIGHTS

NEW



CN-E20-50MM T2.4 L F

Compatible with 8K cameras

HDR Compatible

NEW



CN-E45-135MM T2.4 L F

Consistent color balance

Reduced focus breathing

11-blade iris



CN-E14-35MM T1.7 L S
CN-E14-35MM T1.7 L SP

Super 35mm compatible

Brightness of large aperture ratio T1.7



CN-E31.5-95MM T1.7 L S
CN-E31.5-95MM T1.7 L SP

Compatible with 8K cameras

Gear pitch is set at 0.8mm

Dedicated Accessories Relay kit (sold separately)

Mount kit replacement (sold separately)

PRIME Lens Series: Highlights

Covers Full-frame, Super 35mm and APS-C Sensors

The lenses are also compatible with the large imaging area of cameras equipped with a full-size 35mm-equivalent CMOS sensor.

Light, Compact

Small and light among many conventional cinema lenses, to meet a variety of shooting needs.

Standard Accessories Supported

Supports industry-standard accessories such as power-drive devices and matte boxes.

Accepts 105mm filters (except for 14mm)

PL or other individual filters 105mm in diameter can be attached to the end of the lens, enabling filter work in handheld shooting or other scenarios without using a matte box.

Phosphorescent Indicators

To improve visibility in nighttime and dark area shooting, indicator markings with phosphorescent paint have been adopted for the front barrel (for right-side viewing).

Fast Aperture

Shallow Depth of Field and Low Light shooting are made easier with a fast aperture, allowing for creative freedom.

Unified Front Lens Diameter

Compact Zoom and Prime lenses have the same front lens diameters, allowing for a single mattbox solution.

Prime Lens Series

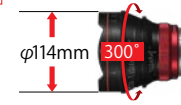

11-Blade Iris

With the increased number of iris blades, users can get natural bokeh that appears more circular, from maximum to minimum aperture. The use of an odd number of blades diffuses light rays in high-brightness subjects and renders images more artistically pleasing.

RF

Canon's first cinema lenses equipped with its RF mount - combine high optical performance for 4K and 8K shooting, cinema-style operability, and RF mount transmission functionality.

Consistent Torque

Control Rings maintain the right amount of resistance while offering outstanding usability with consistent operating torque.

Switchable Unit for Focus Marking

The outer piece on marked focus rings can be switched from non-metric to metric labeling.

CINE-SERVO: HIGHLIGHTS



**CN20 X 50 IAS H (EF/PL)
CINE-SERVO 50-1000MM**

Class Leading

Telephoto Focal Length

S35 Image Circle

Portable Lens Optimized for Field Usage

With 1.5 extender (75 - 1500mm)

When extender is engaged, the lens covers a full frame image circle.

Compatible with Broadcast Zoom/Focus Demands

NEW



**CN10 X 25 IAS S (EF/PL)
CINE-SERVO 25-250MM**

8K Image Quality

Medium Telephoto Lens in a Handheld Friendly Housing

S35 Image Circle

With 1.5 extender (37.5 - 375mm)

When extender is engaged, the lens covers a full frame image circle.



**CN7 X 17 KAS T (RF/PL)
CINE-SERVO 17-120MM**

Wide Angle Lens With 7x Zoom Ratio

8K Image Quality

S35 Image Circle

Balanced for Handheld Shooting

NEW



**CN8 X 15 IAS S (EF/PL)
CINE-SERVO 15-120MM**

4K, 8K, HDR

Super 35mm and Full Frame compatible

11 iris blades

15-120mm focal length (22.5-180mm with Extender)

Drive Unit

Removable Drive Unit

Canon CINE-SERVO lenses include a drive unit that provides the same user experience as found in our broadcast lenses. Removing the drive unit allows for full manual operation of the lenses.



■ No Initialization

Initialization of the drive unit is not required at power-on as compared to other conventional servo drive units. Immediate startup helps contribute to more efficient shooting.

Compatible With Standard Broadcast Demands

Demand Supported

Compatible with Canon's standard broadcast industry demands such as ZSD-300D and FPD-400D. Canon's 8-pin demand* can be connected via a conversion cable.

Enables High-Precision, Natural Composition

Virtual Studio System

A high precision 16-bit encoder (zoom and focus only) makes connection to various virtual studio systems possible. Three 20-pin terminals allow a virtual connection even when zoom and focus demands are connected.



** Iris operation is also possible by connecting FDJ-P01 via conversion cable. It will be selected as either virtual output or iris operation.*

Peripheral Illumination Correction

EF Mount Communication Protocol Support¹

Information communication is possible via CINEMA EOS SYSTEM cameras and mounts. It is possible to record lens information at the time of shooting and peripheral illumination correction².

**1: ZOOM Lenses are excluded. Only EF mounted lenses are supported.*

**2: Some lenses require a camera firmware update. Some lenses are scheduled to be handled by firmware update.*

Supports Broadcast Industry Standards

12-Pin Serial Communication*

Supports 12-pin serial communication which is a broadcasting communication standard.

** Applicable lens: CINE-SERVO Lens series.*

It is necessary for the camera side to support 12-pin serial communication.

Supports Communication Standards of Film Production Industry

/i Technology Compatible*

Canon's PL-mount CINE-SERVO lenses are compatible with Cooke's "/i Technology" communication standard which has been widely adopted throughout the video production industry. Focus/zoom/aperture position data can be sent to the corresponding camera, recorded and displayed.

** Applicable lens: PL mount lens of CINE-SERVO Lens series only.*

The camera side must support /i Technology.

Communication is possible when drive unit is installed.

COMPACT-SERVO Lens Series: Highlights

Refined Iris Mechanism

- Seamless Manual Control Capability
- 9-Blade Iris
- Iris Closing

Compatible with EF-mount Cameras

High Level 4K Optical Performance

Covers Super 35mm and APS-C Sensors



Image Stabilization

Focus Ring Supports 0.8 Gear Pitch Follow Focus Accessories

Minimized Focus Breathing

Compact and Lightweight for Increased Mobility

Enhanced Servo Drive Unit

- Servo Control Capability for Zoom, Focus, and Iris
- Compatible with broadcast style servo lens controllers
- Optional ZSG-C10 Grip

COMPACT-SERVO 4K

FLEX ZOOM Lens Series

Appearance		CN-E20-50mm T2.4 L F CN-E20-50mm T2.4 L FP 		CN-E45-135mm T2.4 L F CN-E45-135mm T2.4 L FP 	
Model Name		CN-E20-50mm T2.4 L F	CN-E20-50mm T2.4 L FP	CN-E45-135mm T2.4 L F	CN-E45-135mm T2.4 L FP
Mount		EF Mount	PL Mount	EF Mount	PL Mount
Zoom Ratio		2.5x		3x	
Focal Length		20 - 50 mm		45 - 135 mm	
Maximum diameter ratio (T-number)		T 2.4			
Number of iris blades		11			
Angle of View	Aspect ratio 1.9:1 Dimensions 40.96 x 21.6 mm	91.4° x 56.7° at 20 mm 44.5° x 24.4° at 50 mm		48.9° x 27.0° at 45 mm 17.3° x 9.1° at 135 mm	
	Aspect ratio 1.5:1 Dimensions 36 x 24 mm	84.0° x 61.9° at 20 mm 39.6° x 27.0° at 50 mm		43.6° x 29.9° at 45 mm 15.2° x 10.2° at 135 mm	
	Aspect ratio 1.78:1 Dimensions 35.7 x 20.1 mm	83.5° x 53.4° at 20 mm 39.3° x 22.7° at 50 mm		43.3° x 25.2° at 45 mm 15.1° x 8.5° at 135 mm	
	Aspect ratio 1.9:1 Dimensions 38.1 x 20.1 mm	87.2° x 53.4° at 20 mm 41.7° x 22.7° at 50 mm		45.9° x 25.2° at 45 mm 16.1° x 8.5° at 135 mm	
Minimum Shooting Distance		0.6 m / 2'		1.0 m / 3'4"	
Shooting range at closest approach	1.9:1 40.96 x 21.6 mm	74.5 x 39.3 cm at 20 mm 28.4 x 15.0 cm at 50 mm		77.1 x 40.6 cm at 45 mm 24.7 x 13.0 cm at 135 mm	
	1.5:1 36 x 24 mm	65.5 x 43.7 cm at 20 mm 24.9 x 16.6 cm at 50 mm		67.7 x 45.2 cm at 45 mm 21.7 x 14.5 cm at 135 mm	
	1.78:1 35.7 x 20.1 mm	64.9 x 36.6 cm at 20 mm 24.7 x 13.9 cm at 50 mm		67.2 x 37.8 cm at 45 mm 21.6 x 12.1 cm at 135 mm	
	1.9:1 38.1 x 20.1 mm	69.3 x 36.6 cm at 20 mm 26.4 x 13.9 cm at 50 mm		71.7 x 37.8 cm at 45 mm 23.0 x 12.1 cm at 135 mm	
Front diameter		Φ 114 mm			
Outer dimensions (w x h x d)		Approx. 131.2 x 133.6 x 241.3 mm	Approx. 131.2 x 133.6 x 233.3 mm	Approx. 131.2 x 133.6 x 246.4 mm	Approx. 131.2 x 133.6 x 238.4 mm
Weight		Approx. 3.3 kg		Approx. 3.4 kg	
Appearance		CN-E14-35mm T1.7 L S CN-E14-35mm T1.7 L SP 		CN-E31.5-95mm T1.7 L S CN-E31.5-95mm T1.7 L SP 	
Model Name		CN-E14-35mm T1.7 L S	CN-E14-35mm T1.7 L SP	CN-E31.5-95mm T1.7 L S	CN-E31.5-95mm T1.7 L SP
Mount		EF Mount	PL Mount	EF Mount	PL Mount
Zoom Ratio		2.5x		3x	
Focal Length		14 - 35 mm		31.5 - 95 mm	
Maximum diameter ratio (T-number)		T 1.7			
Number of iris blades		11			
Angle of View	Aspect ratio 1.78:1 Dimensions 24.6 x 13.8 mm	82.6° x 52.5° at 14 mm 38.7° x 22.3° at 35 mm		42.7° x 24.7° at 31.5 mm 14.8° x 8.3° at 95 mm	
	Aspect ratio 1.9:1 Dimensions 26.2 x 13.8 mm	86.2° x 52.5° at 14 mm 41.0° x 22.3° at 35 mm		45.2° x 24.7° at 31.5 mm 15.7° x 8.3° at 95 mm	
Minimum Shooting Distance		0.6 m / 2'		1.0 m / 3'4"	
Shooting range at closest approach	1.78:1 24.6 x 13.8 mm	63.5 x 35.6 cm at 14 mm 24.2 x 13.6 cm at 35 mm		65.2 x 36.6 cm at 31.5 mm 20.9 x 11.7 cm at 95 mm	
	1.9:1 26.2 x 13.8 mm	67.6 x 35.6 cm at 14 mm 25.8 x 13.6 cm at 35 mm		69.4 x 36.6 cm at 31.5 mm 22.3 x 11.7 cm at 95 mm	
Front diameter		Φ 114 mm			
Outer dimensions (w x h x d)		Approx. 131.2 x 133.6 x 241.3 mm	Approx. 131.2 x 133.6 x 233.3 mm	Approx. 131.2 x 133.6 x 246.4 mm	Approx. 131.2 x 133.6 x 238.4 mm
Weight		Approx. 3.4 kg		Approx. 3.5 kg	

※ Lenses compatible with Super 35mm Sensor cameras.

*1: Aspect ratio 1.78: 1, Screen size 24.0 x 13.5 mm. *2: Aspect ratio 1.78:1, Screen size 24.6 x 13.8 mm

SUMIRE PRIME Lens Series

Sumire Prime

CN-E14mm T3.1 FP X	CN-E20mm T1.5 FP X	CN-E24mm T1.5 FP X	CN-E35mm T1.5 FP X	CN-E50mm T1.3 FP X	CN-E85mm T1.3 FP X	CN-E135mm T2.2 FP X
						
CN-E14mm T3.1 FP X	CN-E20mm T1.5 FP X	CN-E24mm T1.5 FP X	CN-E35mm T1.5 FP X	CN-E50mm T1.3 FP X	CN-E85mm T1.3 FP X	CN-E135mm T2.2 FP X
PL Mount	PL Mount	PL Mount	PL Mount	PL Mount	PL Mount	PL Mount
–	–	–	–	–	–	–
14mm	20mm	24mm	35mm	50mm	85mm	135mm
T3.1	T1.5	T1.5	T1.5	T1.3	T1.3	T2.2
11	11	11	11	11	11	11
104.3°×81.2° *1	84.0°×61.9° *1	73.7°×53.1° *1	54.4°×37.8° *1	39.6°×27.0° *1	23.9°×16.1° *1	15.2°×10.2° *1
82.6°×52.5° *2	63.2°×38.1° *2	54.3°×32.1° *2	38.7°×22.3° *2	27.6°×15.7° *2	16.5°×9.3° *2	10.4°×5.9° *2
0.20m / 8"	0.30m / 12"	0.30m / 12"	0.30m / 12"	0.45m / 18"	0.95m / 3'2"	1.0m / 3'3"
25.2×16.8cm *1	33.8×22.5cm *1	28.8×19.2cm *1	20.2×13.5cm *1	25.0×16.7cm *1	34.4×22.9cm *1	21.1×14.1cm *1
17.2×9.7cm *2	23.1×13.0cm *2	19.7×11.0cm *2	13.8×7.7cm *2	17.1×9.6cm *2	23.5×13.2cm *2	14.4×8.1cm *2
114mm	114mm	114mm	114mm	114mm	114mm	114mm
–	UV/105 P1 filter	UV/105 P1 filter	UV/105 P1 filter	UV/105 P1 filter	UV/105 P1 filter	UV/105 P1 filter
4.66×4.66×3.39 in. (118.4×118.4×86.0mm)	4.66×4.66×3.68 in. (118.4×118.4×93.5mm)	4.66×4.66×3.68 in. (118.4×118.4×93.5mm)	4.66×4.66×3.68 in. (118.4×118.4×93.5mm)	4.66×4.66×3.68 in. (118.4×118.4×93.5mm)	4.66×4.66×3.68 in. (118.4×118.4×93.5mm)	4.66×4.66×4.24 in. (118.4×118.4×107.6mm)
2.65 lbs (1.2kg)	2.65 lbs (1.2kg)	2.65 lbs (1.2kg)	2.43 lbs (1.1kg)	2.43 lbs (1.1kg)	2.87 lbs (1.3kg)	3.09 lbs (1.4kg)

※ Lenses compatible with Full-frame and Super 35mm Sensor cameras.

*1: Aspect ratio 1.5:1, Screen size 36.0 × 24.0 mm. *2: Aspect ratio 1.78:1, Screen size 24.6 × 13.8 mm.

PRIME Lens Series

CN-R14mm T3.1 L F	CN-R20mm T1.5 L F	CN-R24mm T1.5 L F	CN-R35mm T1.5 L F	CN-R50mm T1.3 L F	CN-R85mm T1.3 L F	CN-R135mm T2.2 L F
						
CN-R14mm T3.1 L F	CN-R20mm T1.5 L F	CN-R24mm T1.5 L F	CN-R35mm T1.5 L F	CN-R50mm T1.3 L F	CN-R85mm T1.3 L F	CN-R135mm T2.2 L F
RF Mount	RF Mount	RF Mount	RF Mount	RF Mount	RF Mount	RF Mount
–	–	–	–	–	–	–
14mm	20mm	24mm	35mm	50mm	85mm	135mm
T3.1	T1.5	T1.5	T1.5	T1.3	T1.3	T2.2
11	11	11	11	11	11	11
104.3°×81.2° *1	84.0°×61.9° *1	73.7°×53.1° *1	54.4°×37.8° *1	39.6°×27.0° *1	23.9°×16.1° *1	15.2°×10.2° *1
82.6°×52.5° *2	63.2°×38.1° *2	54.3°×32.1° *2	38.7°×22.3° *2	27.6°×15.7° *2	16.5°×9.3° *2	10.4°×5.9° *2
0.20m / 8"	0.30m / 12"	0.30m / 12"	0.30m / 12"	0.45m / 18"	0.95m / 3'2"	1.0m / 3'3"
24.8×16.5cm *1	33.8×22.5cm *1	28.8×19.2cm *1	20.1×13.4cm *1	24.9×16.6cm *1	34.3×22.9cm *1	21.1×14.1cm *1
16.9×9.5cm *2	23.1×13.0cm *2	19.7×11.0cm *2	13.7×7.7cm *2	17.0×9.5cm *2	23.4×13.1cm *2	14.4×8.1cm *2
114mm	114mm	114mm	114mm	114mm	114mm	114mm
–	UV/105 P1 filter	UV/105 P1 filter	UV/105 P1 filter	UV/105 P1 filter	UV/105 P1 filter	UV/105 P1 filter
4.66×4.66×3.70 in. (118.4×118.4×94.0mm)	4.66×4.66×4.0 in. (118.4×118.4×101.5mm)	4.66×4.66×4.0 in. (118.4×118.4×101.5mm)	4.66×4.66×4.0 in. (118.4×118.4×101.5mm)	4.66×4.66×4.0 in. (118.4×118.4×101.5mm)	4.66×4.66×4.0 in. (118.4×118.4×101.5mm)	4.66×4.66×4.55 in. (118.4×118.4×115.6mm)
2.65 lbs (1.2kg)	2.65 lbs (1.2kg)	2.65 lbs (1.2kg)	2.43 lbs (1.1kg)	2.43 lbs (1.1kg)	2.87 lbs (1.3kg)	3.09 lbs (1.4kg)

※ Lenses compatible with Full-frame and Super 35mm Sensor cameras.

*1: Aspect ratio 1.5:1, Screen size 36.0 × 24.0 mm. *2: Aspect ratio 1.78:1, Screen size 24.6 × 13.8 mm.

CINE-SERVO Lens Series

Appearance		CN7 X 17 KAS T/RF CN7 X 17 KAS T/PL 		CN10x25 IAS S/E1 CN10x25 IAS S/P1 	
Model Name		CN7 X 17 KAS T/RF	CN7 X 17 KAS T/PL	CN10x25 IAS S/E1	CN10x25 IAS S/P1
Mount		RF Mount	PL Mount	RF Mount	PL Mount
Zoom Ratio		7x		10x	
Focal Length		17 ~ 120mm		25 ~ 250mm	37.5 ~ 375mm
Max. Relative Aperture (T-Number)		T2.95 17 ~ 91mm / T3.9 120mm		T2.95 25 ~ 187mm / T3.95 250mm	T4.4 37.5 ~ 281mm / T5.9 375mm
Iris Blades		11			
Angle of View	1.5:1 36.0x24.0mm	71.8°×44.2° 17mm 11.7°×6.6° 120mm ^{*1}		51.3°×35.5° 37.5mm ^{*3} 5.5°×3.7° 375mm ^{*3}	
	1.9:1 26.2x13.8mm	75.2°×44.2° 17mm 12.5°×6.6° 120mm ^{*2}		55.3°×30.9° 25mm 6.0°×3.2° 250mm	
M.O.D. (Minimum Object Distance)		0.85m/2.8'		1.2m/4.0'	
Object Dimensions at M.O.D	1.5:1 36.0x24.0mm	86.3×48.4cm 17mm 12.0×6.7cm 120mm ^{*1}		84.4×56.2cm 37.5mm ^{*3} 8.5×5.7cm 375mm ^{*3}	
	1.9:1 26.2x13.8mm	92.1×48.5cm 17mm 12.7×6.7cm 120mm ^{*2}		92.1×48.5cm 25mm 9.3×4.9cm 250mm	
Front Diameter		114mm			
Filter Diameter		CL/112mm			
Approx. Size (WxHxL)		6.86x4.92x10.35 in. (174.2×125.0×262.9mm)	6.86x4.92x10.04 in. (174.2×125.0×254.9mm)	7.6x5.2x11.1 in. (186.7×131.7×282.1mm)	7.6x5.2x10.8 in. (186.7×131.7×274.1mm)
Approx. Weight		6.39 lbs (2.9kg)		6.7 lbs (3.06kg)	
Appearance		CN8x15 IAS S/E1 CN8x15 IAS S/P1 		CN20x50 IAS H/E1 CN20x50 IAS H/P1 	
Model Name		CN8x15 IAS S/E1	CN8x15 IAS S/P1	CN20x50 IAS H/E1	CN20x50 IAS H/P1
Mount		RF Mount	PL Mount	RF Mount	PL Mount
Zoom Ratio		8x		20x	
Focal Length		15 ~ 120mm	22.5 ~ 180mm [*]	50 ~ 1000mm	75 ~ 1500mm ^{*4}
Max. Relative Aperture (T-Number)		T2.95 15 ~ 90mm / T3.95 120mm	T4.4 at 22.5 - 135 mm / T5.9 at 180 mm [*]	T5.0 (50-560mm) / T8.9 (1000mm)	T7.5 (75-840mm) / T13.35 (1500mm) ^{*4}
Iris Blades		11			
Angle of View	1.78:1 24.6x13.8mm	78.7°×49.4° 15 mm 57.3°×34.1° 22.5 mm [*]	11.7°×6.6° 120 mm 7.8°×4.4° 180 mm [*]		
	1.9:1 26.2x13.8mm	82.3°×49.4° 15 mm 60.4°×34.1° 22.5 mm [*]	12.5°×6.6° 120 mm 8.3°×4.4° 180 mm [*]	29.4°×15.7° 50mm 1.5°×0.8° 1000mm ^{*2}	19.8°×10.5° 75mm 1.0°×0.5° 1500mm ^{*2, *4}
	1.9:1 38.1x20.1mm	80.5°×48.1° 22.5 mm [*]	12.1°×6.4° 180 mm [*]		
	1.5:1 36.0x24.0mm	77.3°×56.1° 22.5 mm [*]	11.4°×7.6° 180 mm [*]	27.6°×15.7° 50mm 1.4°×0.8° 1000mm ^{*1}	18.6°×10.5° 75mm 0.9°×0.5° 1500mm ^{*1, *4}
M.O.D. (Minimum Object Distance)		0.85m/2.8'		3.5m/11.5'	
Object Dimensions at M.O.D	1.78:1 24.6x13.8mm	93.0×52.1cm 15 mm 62.0×34.7cm 22.5mm [*]	11.3×6.3cm 120 mm 7.5×4.2cm 180 mm [*]		
	1.9:1 26.2x13.8mm	99.0×52.1cm 15 mm 66.0×34.7cm 22.5 mm [*]	12.0×6.3cm 120 mm 8.0×4.2cm 180 mm [*]	148.3×78.1cm 50mm 7.8×4.1cm 1000mm ^{*2}	98.9×52.1cm 75mm 5.2×2.7cm 1500mm ^{*2, *4}
	1.9:1 38.1x20.1mm	96.0×50.6cm 22.5 mm [*]	11.6×6.1cm 180 mm [*]		
	1.5:1 36.0x24.0mm	90.7×60.5cm 22.5 mm [*]	11.0×7.3cm 180 mm [*]	139.3×78.1cm 50mm 7.3×4.1cm 1000mm ^{*1}	92.9×52.1cm 75mm 4.9×2.7cm 1500mm ^{*1, *4}
Front Diameter		114mm		136.0mm	
Filter Diameter		CL/112mm		CL/127mm, UV/127mm	
Approx. Size (WxHxL)		7.35x5.18x11.61 in. (186.7×131.7×294.9mm)	7.35x5.18x11.29 in. (186.7×131.7×286.9mm)	6.89x6.72x16.27 in. (175.0×170.6×413.2mm)	6.89x6.72x15.95 in. (175.0×170.6×405.2mm)
Approx. Weight		7.50 lbs (3.4kg)		14.55 lbs (6.6kg)	

*: Lenses compatible with Super 35mm Sensor cameras.

*1: Aspect ratio 1.78:1, Screen size 24.6 x 13.8 mm. *2: Aspect ratio 1.9:1, Screen size 26.2 x 13.8 mm. *3: When using internal extender (1.5x). *4: When using the built-in extender.

COMPACT-SERVO Lens Series

		CN-E18-80mm T4.4 L IS KAS S	CN-E70-200mm T4.4 L IS KAS S
Appearance			
Model Name		CN-E18-80mm T4.4 L IS KAS S	CN-E70-200mm T4.4 L IS KAS S
Mount		EF Mount	EF Mount
Zoom Ratio		4.4x	2.8x
Focal Length		18 - 80mm	70 - 200mm
Max. Relative Aperture (T-Number)		T4.4 18 - 80mm	T4.4 70 - 200mm
Iris Blades		9	9
Angle of View	1.5:1 36.0x24.0mm	68.7°×41.9° 18mm 17.5°×9.9° 80mm ^{*1}	19.9°×11.3° 70mm 7.0°×4.0° 200mm ^{*1}
	1.9:1 26.2x13.8mm	72.1°×41.9° 18mm 18.6°×9.9° 80mm ^{*2}	21.2°×11.3° 70mm 7.5°×4.0° 200mm ^{*2}
M.O.D. (Minimum Object Distance)		0.5m/1.7'	1.2m/4.0'
Object Dimensions at M.O.D	1.5:1 36.0x24.0mm	43.4×24.3cm 18mm 9.5×5.3cm 80mm ^{*1}	31.3×17.5cm 70mm 11.5×6.4cm 200mm ^{*1}
	1.9:1 26.2x13.8mm	46.2×24.3cm 18mm 10.1×5.3cm 80mm ^{*2}	33.3×17.5cm 70mm 12.2×6.4cm 200mm ^{*2}
Front Diameter		84mm	84mm
Filter Diameter		77mm Protect Filter, PL-C B 77mm	77mm Protect Filter, PL-C B 77mm
Approx. Size (WxHxL)		3.67x4.22x7.18 in. (93.4x107.2x182.3mm)	3.67x4.22x7.18 in. (93.4x107.2x182.3mm)
Approx. Weight		2.65 lbs (1.2kg) (including servo unit)	2.76 lbs (1.25kg) (including servo unit)

※ Lenses compatible with Super 35mm Sensor cameras.

*1: Aspect ratio 1.78:1, Screen size 24.6 x 13.8 mm.

*2: Aspect ratio 1.9:1, Screen size 26.2 x 13.8 mm.

COMPACT-SERVO Lens Accessories

ZSG-C10



- Rocker seesaw
- Start/Stop button
- ONE-SHOT AF button
- 20-pin cable ^{*1}
- Flexible mounting angle.

※ Sold separately.

※ Support strut, bracket, hex wrench included.

*1: For connection to the lens body.

CINE-SERVO Lens / COMPACT-SERVO Lens Accessories

Category	Model	Notes	CN8x15 IAS S/E1 CN8x15 IAS S/P1	CN7 X 17 KAS T/RF CN7 X 17 KAS T/PL	CN10x25 IAS S/E1 CN10x25 IAS S/P1	CN20x50 IAS H/E1 CN20x50 IAS H/P1	CN-E18-80mm CN-E70-200mm
Focus Demand	FPD-400D	There is no need for an optional cable.	●	●	●	●	●
	FDJ-D02	BDC - 11 cable (20p - 18p) is required.	●	●	●	●	—※1 ※2
	FDJ-P01	BDC - 21 cable (20p - 12p) is required.	●	●	●	●	—
	FDJ-S01	BDC - 21 cable (20p - 12p) is required.	●	●	●	●	—
	FDJ-S31	BDC - 21 cable (20p - 12p) is required.	●	●	●	●	—
	FDJ-S41	BDC - 21 cable (20p - 12p) is required.	●	●	●	●	—
vZoom Demand	ZSD-300D	There is no need for an optional cable.	●	●	●	●	●
	ZSD-15MII	CC-2008 Cable (20p - 8p) is required.	●	●	●	●	●※1 ※2
	ZDJ-D02	BDC-11 cable (20p-18p) is required.	●	●	●	●	—※1 ※2
	ZDJ-P01	BDC - 21 cable (20p - 12p) is required.	●	●	●	●	—
	ZDJ-S01	BDC - 21 cable (20p - 12p) is required.	●	●	●	●	—
Iris Demand	FDJ-D02	BDC - 11 cable (20p - 18p) is required.	●	●	●	●	—
	FDJ-P01	BDC - 21 cable (20p - 12p) is required.	●	●	●	●	—
Demand Cable	BDC-21	20p-12p cable. Required for FDJ-P01 / ZDJ-P01.	●	●	●	●	—
	BDC-11	20p - 18p cable. Required for FDJ-D02 / ZDJ-D02.	●	●	●	●	—
	CC-2008	20p - 8p cable. Required for ZSD-15II	●	●	●	●	●
Clear Filter	77mm Protect Filter	77mm Protect filter	—	—	—	—	●
	CL/112mm	CL/112mm	●	●	●	—	—
	CL/127mm	CL/127mm	—	—	—	●	—
Polarization Filter	PL-C B 77mm	PL-C B 77mm	—	—	—	—	●
Close-Up Lens	CL-UP500D 77mm	CL-UP500D 77mm	—	—	—	—	●
Lens Holder	LH-CN7/02	Used when you want to improve the degree of freedom of Focus ring rotation operation. (The lens support attached to the main unit is supported on the front side.)	●	●	●	—	—
Power Cable	C-ZLPRO*	For power supply from external battery. 12-pin - Dtap cable.	●	●	●	●	—
12p-12p Extension Cable	12p-12p CABLE 200mm	Used for extending 12p cable to pair with EU-V2 (C300iii, C500ii Accessory).	●	●	●	●	—

* Made by IDX.

※1: Multiple controllers can not be connected at the same time (because there is only one connector). When installing the ZSG - C10 and enabling the operation on the grip side, you can not connect the external controller.

※2: For use in studio configurations, an optional Zacuto Z-CNYC Y-cable can be used to connect zoom and focus controllers to each lens. This configuration allows for simultaneous zoom and focus operation with COMPACT-SERVO lenses.

※3: Some vignetting occurs when used in combination with RED's Epic system.



Lens System Basic Configuration

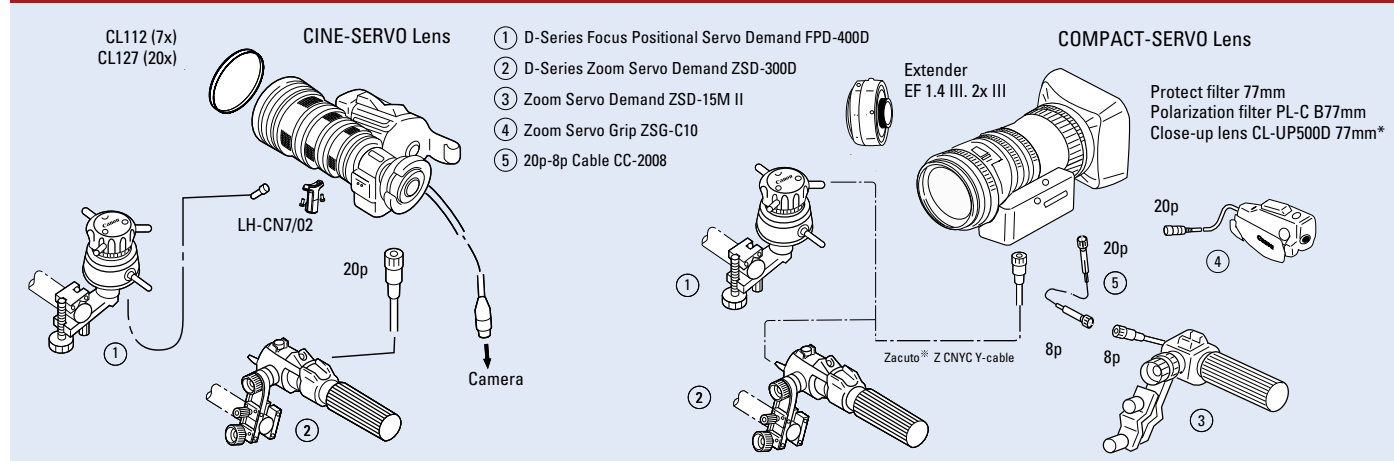

* Some vignetting occurs when used in combination with RED's Epic system.

※ The optional Zacuto® Z-CNYC Y-cable allows for simultaneous use of zoom and focus controllers with both Compact-Servo lenses.



SOUTH & SOUTHEAST ASIA
REGIONAL HEADQUARTERS

Broadcast Lens

Cine Lens

Distributed by